



DH100F

USER MANUAL

EnerCore
PV+ESS All-in-one Cabinet

Content

Content.....	1
Statement of Law.....	1
Revised History.....	1
1. Guideline.....	2
1.1. Use of Manuals.....	2
1.2. Symbol and Abbreviation.....	2
2. Safety Instructions.....	4
2.1. Safety Principle.....	4
2.2. Operator Qualifications.....	4
2.3. Environmental Safety Requirements.....	5
2.4. Electrical Safety Requirements.....	5
2.5. Transportation and Installation Safety Requirements.....	6
2.6. Daily Operation and Maintenance.....	6
2.7. Product Obsolescence.....	7
3. Product Description.....	8
3.1. Product Overview.....	8
3.2. Product Model.....	9
3.3. Product Configuration.....	9
3.4. System Parameters.....	10
3.5. Appearance Design.....	12
3.6. Internal Design.....	14
3.7. Main Modules.....	14
4. Transportation And Storage.....	21
4.1. Unpacking And Checking.....	21
4.2. Lifting Transportation.....	21
4.3. Forklift Transportation.....	22
4.4. Storage Requirement.....	23

5.	Installation.....	25
5.1.	Installation Environmental Requirements	26
5.2.	Installation Spatial Requirements.....	27
5.3.	Installation Procedure.....	28
5.4.	Fixed Installation.....	29
5.5.	Preparation Before Installation.....	31
5.6.	Checking Before Wiring	34
5.7.	Pe Wiring	35
5.8.	Electrical Wiring.....	35
5.9.	Communication Wiring	40
5.10.	Meter Installation.....	41
5.11.	Checking After Wiring.....	43
6.	Power On and Power Off.....	44
6.1.	Power On Process.....	44
6.2.	Power Off Process	46
6.3.	Emergency Stop.....	46
7.	HMI Operation.....	48
7.1.	Main Functions	48
7.2.	Operation System Overview.....	49
7.3.	User Login	51
7.4.	Running Information	53
7.5.	Query Data	55
7.6.	EMS Setting.....	55
7.7.	Application Setting Step	63
8.	Fault Description.....	72
9.	System Maintenance	75
10.	Quality Assurance.....	77
11.	Appendix.....	78

Statement of Law

The copyright of this document belongs to Dyness Digital Energy Technology Co., LTD. (the following will be referred to as "Dyness").

No part of this document may be excerpted, translated, annotated or reproduced in any form or by any means without the prior written authorization of Dyness.

It is prohibited to use part or all of the data in the firmware or software developed by the Company for commercial purposes in any way.

It is prohibited to decompile, decrypt or otherwise damage the original program design of the software developed by the Company.

This product complies with the design requirements for environmental protection and personal safety. The storage, use and disposal of the product shall be in accordance with the product manual, relevant contract or relevant laws and regulations.

When products or technologies are updated, customers can check the information on the website of Dyness.

Website: <http://www.dyness.com/>

Please note that products can be modified without prior notice.

Revised History

Revised version	Revision Date	Revision Reason
1.0	2024.05	First publication
1.1	2024.09	1. Correction of figure 2. Overall update

1. Guideline

CAUTION: Read this manual carefully before installing or operating this product. Keep this manual in a safe place for future reference.









1.1. Use of Manuals

- Manual content: this manual mainly introduces the safety precautions, functions and specifications, delivery and storage, installation and wiring, power on/off process, HMI operation, maintenance and quality assurance of this ESS product.
- Applicable population: this manual is suitable for professional technicians who install and maintain the ESS product, as well as users who carry out daily operation. Readers should have certain electrical knowledge.

1.2. Symbol and Abbreviation

This manual may contain the following symbols to emphasize important information, to ensure the safety of the user's personal and property when installing this product, or to facilitate the efficient operation, please read it carefully.

Table 1-1 Symbol Mark

	Indicate that there is high voltage inside the ESS cabinet, so beware of electrocution resulting in personal safety issues.
	Indicate an electrical hazard, all external power connections must be disconnected before maintenance and operation.
	Anti-temperature mark
	Ventilation mark
	Indicate that there is protective earthing (PE) terminal, which is used to prevent electric shock in the event of a fault, and needs to be firmly earthed to ensure operator safety.
	Recycle mark
	Hazardous waste, need professional recycling, can not be put into the trash can
	Instruction (User Manual) mark

References to the following products in this manual are replaced by abbreviations for ease of presentation.

Table 1-2 Abbreviation Definition

Abbreviation	Full name
ESS	Energy Storage System

PCS	Power Conversion System
EMS	Energy Management System
BMS	Battery Management System
BDU	Battery Distribution Unit
SPD	Surge Protection Device
SOC	State of Charge
SOH	State of Health
DC	Direct Current
AC	Alternating Current
PV	Photovoltaic
MPPT	Maximum Power Point Tracking
TMG	Thermo Magnetic Generator
RCD	Residual Current Device
CT	Current Transformer
PE	Protective Earthing

2. Safety Instructions

2.1. Safety Principle

Related safety precautions need to be strictly followed during installation, operation and maintenance. This product is a combined high-voltage DC and three-phase AC system and should only be operated by authorized personnel.

DANGER

- Deadly high voltages are present inside the product, please observe and comply with the warning labels on the product;
- Do not touch the power grid or the contacts connected to it inside the product to prevent the risk of fatal electric shock!
- Damage to the battery may result in electrolyte leakage. If the electrolyte leaks, do not touch the leaking electrolyte or volatile gases and contact the after-sales service team immediately for assistance.

WARNING

- Transportation, installation, maintenance must comply with local regulations and this user manual;
- Installation work must be assigned to a specialized full-time operator.

PROHIBITION

- Risk of damage to the battery system or personal injury or behavior is prohibited;
- Replacement of the modules by the user is prohibited and the company will not be responsible for any damages caused.

2.2. Operator Qualifications

Only qualified electricians or professional personnel can operate the product, the operator should meet the following requirements.

- Shall be familiar with local standards and relevant electricity safety regulations;
- The operator shall have received professional training related to the installation and commissioning of electrical equipment, and should have the ability to respond to emergencies or unexpected situations that may occur during installation or trial operation.
- The operator shall have certain specialized knowledge of electronics, electrical wiring and machinery, and be familiar with electrical and mechanical schematic diagrams;
- The Operator should be fully familiar with equipment protection and standard maintenance, and operations should comply with established safety standards;

2.3. Environmental Safety Requirements

- Do not install and use the product in environments with temperature below -20°C or above 50°C;
- Do not install and use the product near any heat sources or combustible materials;
- Do not install and use the product in areas with frequent movement of personnel;
- Do not expose the product to corrosive gases or liquids;
- Keep the product installation and use away from children and animals;
- The maximum installation altitude for the product should not exceed 3000m, and it should be derated when above 2000m;
- Sufficient space should be reserved for product installation to ensure adequate ventilation;
- Isolation barriers must be set up during installation to prevent any unrelated personnel from entering the site.

2.4. Electrical Safety Requirements

The operator must ensure that all basic information and step-by-step instructions are understood before commissioning and switching off the disconnecting circuit-breaker.



Battery protection safety

Please ensure that during installation, maintenance of the equipment.

- The battery is completely disconnected.
- Have a visible warning sign at the break point to ensure no accidental reconnections.

Ground Fault Protective Safety

- When a ground fault occurs, the original non-electrified part may carry high voltage, and accidental electric shock can lead to personal safety! Ensure that there is no ground fault and take necessary protective measures before operation.

Safety of live line measurements

- Given the presence of high voltages in this equipment, protective measures (e.g., wear insulated gloves, etc.) must be taken during live line measurements, and the operator must be accompanied by a person to ensure personal safety.

Arc protection safety

- Avoid arc, fire and explosion hazards caused by improper operation;
- Prohibit touching uninsulated cables that may be energized;
- When a loose connection occurs in the power cable, or a screw or other component falls out accidentally, do not operate it without authorization, and it must be handled by a qualified professional to avoid causing a larger malfunction.

2.5. Transportation and Installation Safety Requirements



WARNING

Personnel operation regulations

- Forklifts, cranes and other construction machinery must be operated by qualified operators if required on site;
- The operator must wear insulated protective equipment that complies with safety regulations during installation;
- When connecting the power on-site, a professional guardian must be assigned to protect the switches that need to be turned off;
- ensure that it has no electrical connections before installation;
- Each completed project must be checked at least once and cross-checked during the installation process;
- The equipment must be installed in sequence without skipping any steps;

Wiring regulations

- Appropriate measuring devices must be used, appropriate standards and directives must be followed.
- The operating manual of the measuring device must be known before any measurement is carried out;
- Only use equipment specified by Dyness. Failure to use equipment specified by Dyness may result in impaired protection as well as injury to personnel.

Test run after installation

- Only after confirmation by professionals and obtaining permission from local electrical authorities can the equipment be put into operation.
- Before operation, please switch off all distribution circuit breakers, and it is strictly prohibited to disconnect them during product running.



DANGER

- Do not change fuse size or rating value during installation;
- It is not allowed for two or more operators to connect a single wire simultaneously during the wiring process.

2.6. Daily Operation and Maintenance

All operations of the product should follow the instructions in the User Manual. Damage to the equipment caused by violation of these instructions will void the associated liability and warranty. If necessary, contact Dyness Customer Service for repairs.



WARNING

- The software, shell and components of the product may not be changed without

- Dyness authorization. If changed, the corresponding liability and warranty shall be void.
- Do not remove or alter the nameplate;
 - Do not open the cabinet doors in inclement weather such as rain or strong winds;

2.7. Product Obsolescence

When the product as a whole or individual internal components become aged or damaged and need to be discarded, they cannot be disposed as regular waste. Some components inside the product can be recycled and reused. Improper disposal of certain components may cause environmental pollution.

Please contact qualified local professional recycling organization for proper disposal of the product and internal components.

3. Product Description

3.1. Product Overview

The product is an outdoor ESS+PV all-in-one cabinet, including PACK, BDU(include BMS and DC power distribution), DC/DC, MPPT, Distribution module(include EMS and AC power distribution), fire protection system, air conditioner system and so on. Which could provide users with peak-shaving, capacity and demand reduction, dynamic expansion, demand response and other functions. It can be widely used in charging stations, commercial buildings, manufacturing industry and other small industrial and commercial scenarios.

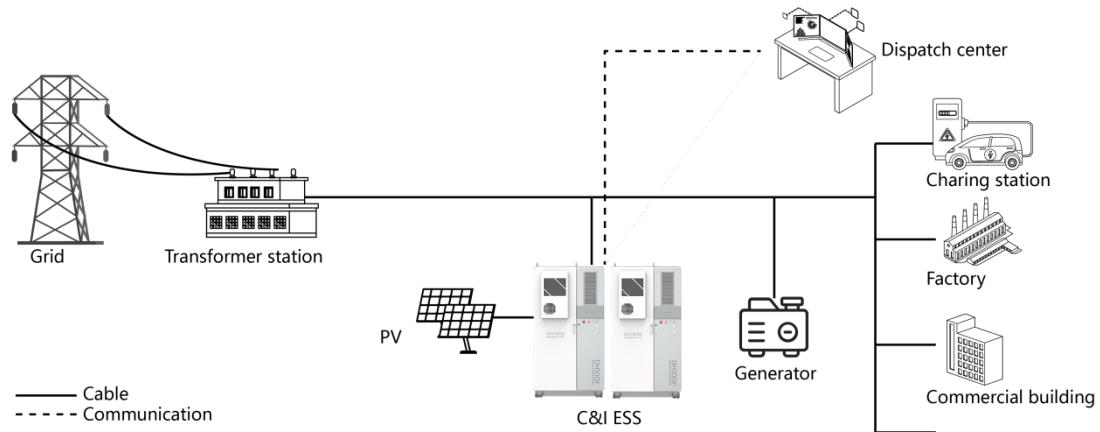

Figure 3-1 System Application

The product supports PV access, generator access and automatic switching of on/off-grid.

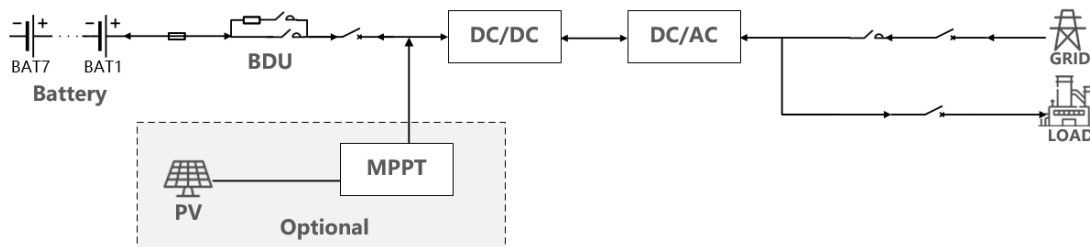

Figure 3-2 System Typology

- 1) Basic function: on-grid scenario, off-grid scenario, switching of on/off-grid;
- 2) Optional function: PV access at the DC side;
- 3) Expansion function: PV and diesel generator access at the AC side(If a diesel generator needs to be connected, please contact Dyness);
- 4) Reserved function: Reserve battery expansion interface, battery PACK can be expanded at the DC side on demand;
- 5) Flexible Capacity: The rated output power/capacity of a single product can be flexibly configured as 35kW/71kWh, 40kW/86kWh, 50kW/100kWh;
- 6) AC expansion: The product supports multiple systems in parallel at AC side, supporting up to 8 sets for on-grid application (up to 4 sets for off-grid application), it can be expanded maximum to 400kW/800kWh.

3.2. Product Model

This manual applies to outdoor air-cooling ESS products (DH100F) of Enercore series. The definition are explained as below:

DH: Dyness high voltage series products

100: battery capacity of standard model

F: Fan/air-cooling system

S: indicate solar, the number after "S" stand for the MPPT channels, "00" means no MPPT module in the initial setting (expandable afterwards), "01" means 1 MPPT module, "02" means 2 MPPT module

L: On&off-grid, the number 01 after L indicates the On&off-grid version

C: indicate system capacity, the number after "C" means the initial system capacity of different model, unit:kWh

The users could choose the number of MPPT module and PACKs as demand, Dyness provide the following model:

Table 3-2 Product Model

No.	Model	Description	PACK	MPPT
1	DH100F-S00L01C70	PV+ESS, no MPPT for initial setting(expandable); System capacity: 71kWh	5pcs	0
2	DH100F-S01L01C70	PV+ESS, 1 MPPT (expandable); System capacity: 71kWh	5pcs	1
3	DH100F-S02L01C70	PV+ESS, 2 MPPT; System capacity: 71kWh	5pcs	2
4	DH100F-S00L01C80	PV+ESS, no MPPT for initial setting(expandable); System capacity: 86kWh	6pcs	0
5	DH100F-S01L01C80	PV+ESS, 1 MPPT (expandable); System capacity: 86kWh	6pcs	1
6	DH100F-S02L01C80	PV+ESS, 2 MPPT; System capacity: 86kWh	6pcs	2
7	DH100F-S00L01C100	PV+ESS, no MPPT for initial setting(expandable); System capacity: 100kWh	7pcs	0
8	DH100F-S01L01C100	PV+ESS, 1 MPPT (expandable); System capacity: 100kWh	7pcs	1
9	DH100F-S02L01C100	PV+ESS, 2 MPPT; System capacity: 100kWh	7pcs	2

Note: 7.DH100F-S00L01C100 and 8.DH100F-S02L01C100 are standard version, the rest are customized version.

3.3. Product Configuration

The product adopt modular design which is more convenient for installation, operation and maintenance.

- 1) The product integrates PACK, BDU (including BMS and DC power distribution), PCS, DC/DC, MPPT, power distribution module(including EMS and AC power distribution), fire protection system, air conditioner system and so on.

- 2) The product is equipped with composite detector (incorporating smoke/gas/temperature detectors), water immersion detector, aerosol and other facilities, making the product safer.
- 3) The product is equipped with EMS, which could achieve effective and reliable energy management, enables remote monitoring and program upgrade through Ethernet, 4G and RS485 network access.
- 4) The product is equipped with breakers, fuses, contactors and other disconnect devices to achieve reliable power cutoff, ensuring personnel and equipment safety.

Table 3-2 Product Configuration List

Module	Function	Qty.	Config.
PACK	For electrical storage	5~7	Standard
PCS	Bi-directional conversion of AC and DC	1	Standard
BDU	BMS: Collect battery information and control battery charging and discharging Power distribution: including breakers, wires, fuses and etc.	1	Standard
DC/DC	Connect the battery and PCS to achieve switching of DC high/low voltage.	1	Standard
MPPT	Support MPPT mode for PV access.	0~2	Optional
Distribution module	EMS: Energy management system.	1	Standard
	Including PV breakers, circuit breakers, fuses and other AC distribution accessories.	1	Standard
Grid switch	Isolate and protect of Grid side.	1	Standard
Load switch	Isolate and protect of Battery side.	1	Standard
Fire protection system	Timely warning of battery thermal runaway and making correct action.	1	Standard
Air conditioner system	Adjust battery working temperature to ensure it works under optimal temperature.	1	Standard

3.4. System Parameters

DH100F parameters is shown as follows (The parameter may vary without notice during product upgrade).

Table 3-3 DH100F Parameter

Model	DH100F-71kWh	DH100F-86kWh	DH100F-100kWh
Battery			
Battery Type	LFP (LiFePO ₄)		
Battery Capacity	280Ah		
Rated Current	140A		
Max. Current	160A		
PACK Configuration	1P16S		
PACK Quantity	5 PACK/Cluster	6 PACK/Cluster	7 PACK/Cluster
Voltage Range	232~288Vdc	278.4~345.6Vdc	324.8~403.2Vdc

Nominal Capacity	71kWh	86kWh	100kWh
AC (On-grid)			
Rated Power	35kW	40kW	50kW
AC Maximum Current	60A	74A	86A
AC Rated Voltage	400Vac		
Wiring Method	3P4L+PE		
Frequency	50Hz/60Hz		
Power Factor	0.8 (Leading)~0.8 (Lagging)		
THDi	< 5% (Rated power)		
AC (Off-grid)			
Rated Power	35kVA	40kVA	50kVA
AC Maximum Current	60A	74A	86A
AC Rated Voltage	400Vac		
Wiring Method	3P4L+PE		
Frequency	50Hz/60Hz		
Unbalanced Load	100%		
THDv	< 3% (Liner load)		
Photovoltaic			
Max. Input Power	25kW*2	30kW*2	35kW*2
Max. Input Current	80A*2		
Short-circuit Current	100A*2		
Max. Voltage	1000Vdc		
Input Voltage	300~1000Vdc	350~1000Vdc	400~1000Vdc
MPPT Path	0~2		
System			
Weight	1500±100kg	1600±100kg	1700±100kg
Dimension (W*D*H)	1200*1224*2258mm		
Max. Efficiency	≥84% (TBD)		
Air Conditioner Power	2kW (Cooling), 1kW (Heating)		
Temperature	-20~50°C (Derating above 45°C)		
Humidity	0~95%RH (Non-condensing)		
Ingress Protection	IP55		
Anti-corrosion Grade	C3		
Cooling Method	Air cooling		
Noise	≤70dB (TBD)		
Elevation	3000m (Derating above 2000m)		
Display	Touch screen		
Fire Protection	Aerosol/Perfluorohexanone		
Communication	Ethernet/4G/RS485		
Certification	CE, TUV		

3.5. Appearance Design

- Dimension: 1200*1224*2258mm (Fixed basement and hanging rings not included)
- Net weight: Approx. 1700kg (Model DH100F-S02L01C100 as reference)
- Product IP grade: IP55
- Anti-corrosion level: C3



Figure 3-3 Product Appearance

The front panel of the product is equipped with an HMI screen, 1 emergency stop button, 3 indicator lights showing the main operating status of the product, and 2 antennas.

HMI screen baffle: Protecting the HMI screen;

Indicator lights from left to right: emergency stop button "EPO", alarm indicator "FAULT", running indicator "RUN" and power indicator "POWER";

Antennas from left to right: 4G, GPS.

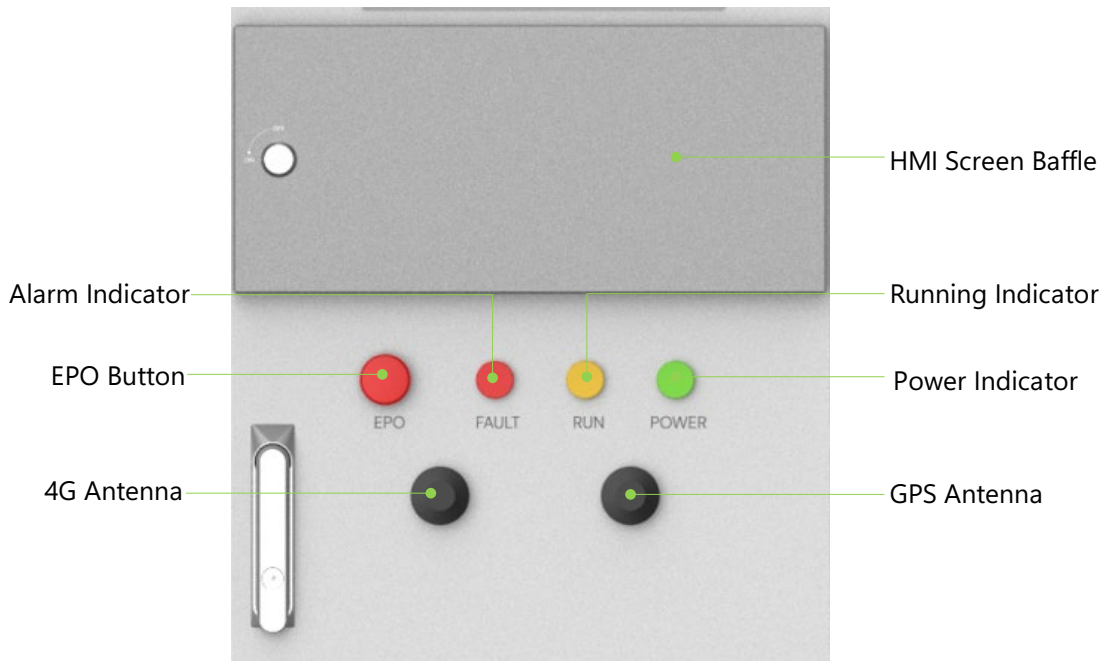

Figure 3-4 Product Indicators

Table 3-4 Indicator Name and Function

NO.	Color	Name	Function
1	●	EPO	The system stops after the EPO button is pressed, and the system needs to be powered down and restarted after the button is restored to recover from the emergency stop fault
2	●	FAULT	Constant light indicates a system malfunction
3	●	RUN	Constant light indicates normal system operation, off indicates standby
4	●	POWER	Constant light indicates power is applied and ready for operation
5	●	4G	Receive and send 4G signals
6	●	GPS	Receive location signals

*** CAUTION: Do not operate the emergency stop button in a non-emergency situation.**

3.6. Internal Design

The product consist of two parts: Battery compartment and electrical compartment.

Battery compartment: PACK, BDU (incorporating DC power distribution and BMS), air conditioner, fire protection system and access control system;

Electrical compartment: MPPT, PCS, DC/DC, Power distribution module (AC power distribution, PV switch and EMS)



Figure 3-5 Internal Structure

3.7. Main Modules

3.7.1. PACK

The PACK adopts 280Ah LFP battery, which have excellent safety, high energy density.

The PACK cell string : 1P16S; Capacity: 14.33kWh /PACK;

The PACK adopts air-forced cooling method by fan, equipped with IP20 grade, pollution-free modular assembly, high structural reliability and low maintenance cost.



Figure 3-6 PACK

Table 3-5 PACK Configuration

Model Number	HV51280F
--------------	----------

String Form	1P16S
Battery Energy (kWh)	14.33
Nominal Voltage (Vdc)	51.2
Nominal Capacity (Ah)	280
Standard Charging/Discharging current (A)	140
Dimension(W*D*H)	568*764*231mm
IP Class	IP20
Operating Temperature	Charging 0°C~+60°C
	Discharging -20°C~+60°C
Operating Humidity	0%~95% RH (Non-condensing)
Storage Temperature	1 Month -20~45°C
	1 Year 0~35°C



WARNING

- When battery leakage occurs, or there is abnormal smell from the battery, if it is difficult to determine whether the electrolyte leaks, please stop using it immediately and contact Dyness or professionals;
- Please do not touch the electrolyte directly, if skin contact accidentally, please flush with plenty of water;
- When handling leaking batteries, make sure that the power supply connected to the battery is off to prevent fire and sparks, and keep the environment well ventilated;
- Wear rubber gloves (insulation voltage>10kV) when handling leaking batteries;
- Please use gauze (ordinary medical gauze) or other liquid absorbent solids to clean the battery leakage;
- The treated battery should be placed in isolation and should not be used again;
- The above operations shall be completed by personnel designated by Dyness or qualified professionals.

3.7.2. PCS

PCS function: PCS is bi-directional current-controllable device that connect the grid and ESS. Its main function is to facilitate energy exchange between the battery and grid, as well as control and manage charging/discharging of the battery. It enables bidirectional conversion between DC and AC, allowing AC power to be converted to DC for battery charging and vice versa, converting DC power from the battery to AC for feeding back into the grid. The product adopts IP20 protection grade. When the product is configured with 7 PACKs, the rated output power is 50kW, when it is configured with 6 or 5 PACKs, the output power will be reduced.

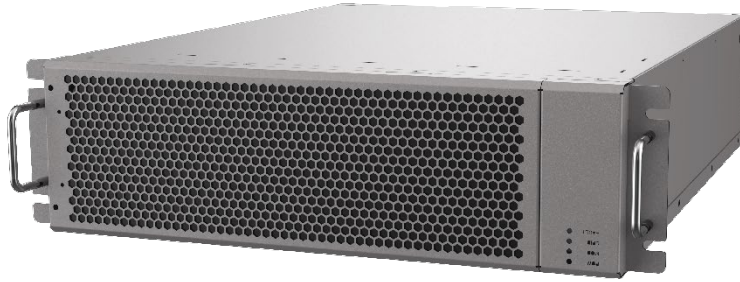

Figure 3-7 PCS (Image Only for Reference)

Notice: please replace the dust cover regularly, if the dust cover is blocked, the temperature will rise abnormally.

3.7.3. DC/DC

DC/DC module function: achieve the switching between high and low DC voltage, used in conjunction with PCS to connect the battery and DC side of PCS, thereby increasing the battery voltage to meet the voltage range required by PCS.

The module is a booster DC / DC module, where the low-voltage side is connected to the battery and the high-voltage side is connected to PCS.

The module has the same size and appearance as the PCS.

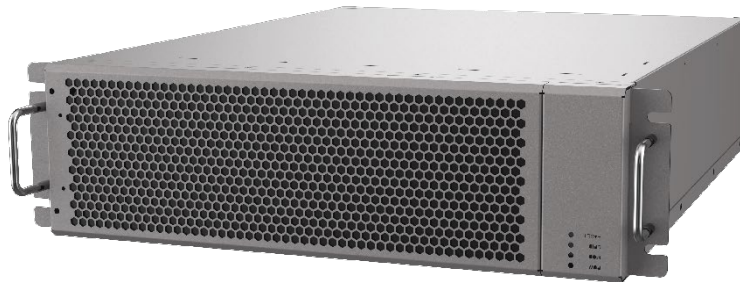

Figure 3-8 DC/DC (Image Only for Reference)

Notice: please replace the dust cover regularly, if the dust cover is blocked, the temperature will rise abnormally.

The module is the same size and appearance as the PCS and can be distinguished by silkscreen.

3.7.4. MPPT

MPPT function: supporting MPPT mode to enhance the efficiency of PV panels or supplying power to Loads via AC/DC.

Protection functions: over-current protection, over-temperature protection, under-voltage protection on the low-voltage side/ high-voltage side, over-power protection, short-circuit protection on the low-voltage side, and reverse connection protection.

The DC input voltage from PV panel need to be higher than the battery voltage, therefore the MPPT low-voltage side is connected to the battery and the high-voltage side is connected to the PV panels.

The number of MPPT module can be chosen from 0 to 2 based on PV power needs.



Figure 3-9 MPPT (Image Only for Reference)

3.7.5. BDU

The BDU module incorporating BMS and DC power distribution.

BMS

- Collect cell information from the PACK BMU, and transmitting it to the EMS.
- Calculate battery SOC and SOH based on the collected information, and execute overall control of the battery system.
- Ensure stable and safe battery functionality through real-time monitoring of battery status.
- Prolong battery lifespan by monitoring battery consistency.



Figure 3-10 BDU

3.7.6. Distribution Module

The distribution module includes AC circuit breaker, contactor, PV breaker, meter, SPD and EMS, etc.

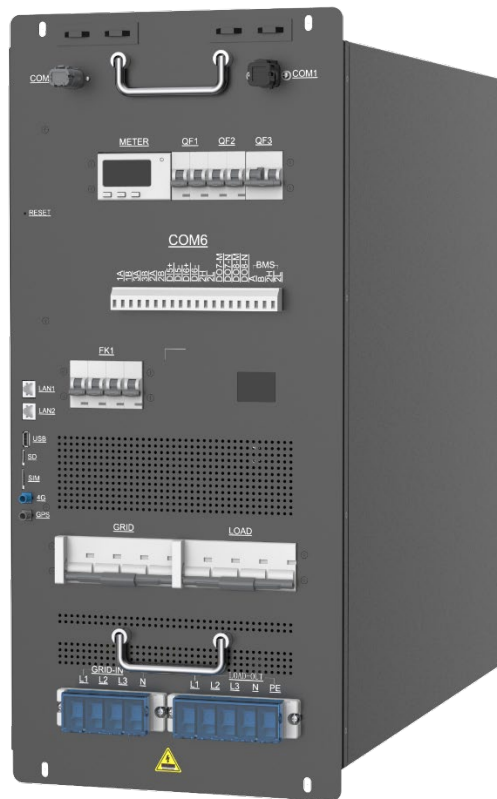

Figure 3-11 Distribution Module

EMS

EMS is an essential part of ESS. It communicate with PCS, BMS, meter, fire protection system, air conditioner and other devices to control the whole ESS. It can achieve functions like peak-valley arbitrage, peak-shaving, self-consumption, battery priority, anti-flowback, transformer protection function. EMS collects local data and signals, ensures the safe, reliable, efficient, economical operation of ESS through internal control strategies.

3.7.7. Security System

This system is equipped with an efficient and reliable firefighting system and access control system to effectively extinguish and alarm in the event of a fire or emergency.

Fire Protection System

The product is equipped with a composite detector (smoke/ temperature/ gas detector) and fire extinguishing agent on the top of the battery compartment. When any of the three built-in detectors detects an anomaly, the system will stop operating and report the anomaly. If two detectors detect anomalies, the fire extinguishing agent will be released to suppress the fire, and a feedback signal will be sent to the EMS which can further relay the information to site monitoring or the user.

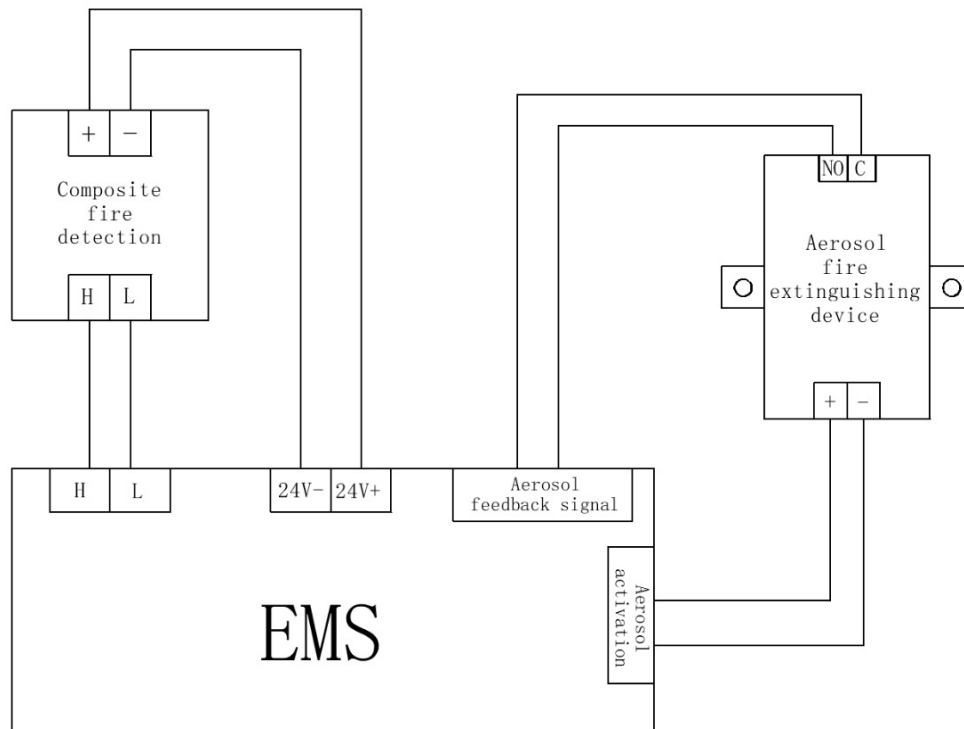

Figure 3-12 Fire Protection Principle

Access Control System

- **Water detector:** Installed at the bottom of the electricity compartment. In the event of an anomaly detected by the water detector, the system will report the anomaly and also stop operating.
- **Travel switch:** Installed at the top of the battery compartment to detect whether the door is tightly closed, preventing rainwater ingress.
- **GPS:** Locate where the system is installed to reduce the risk of theft.

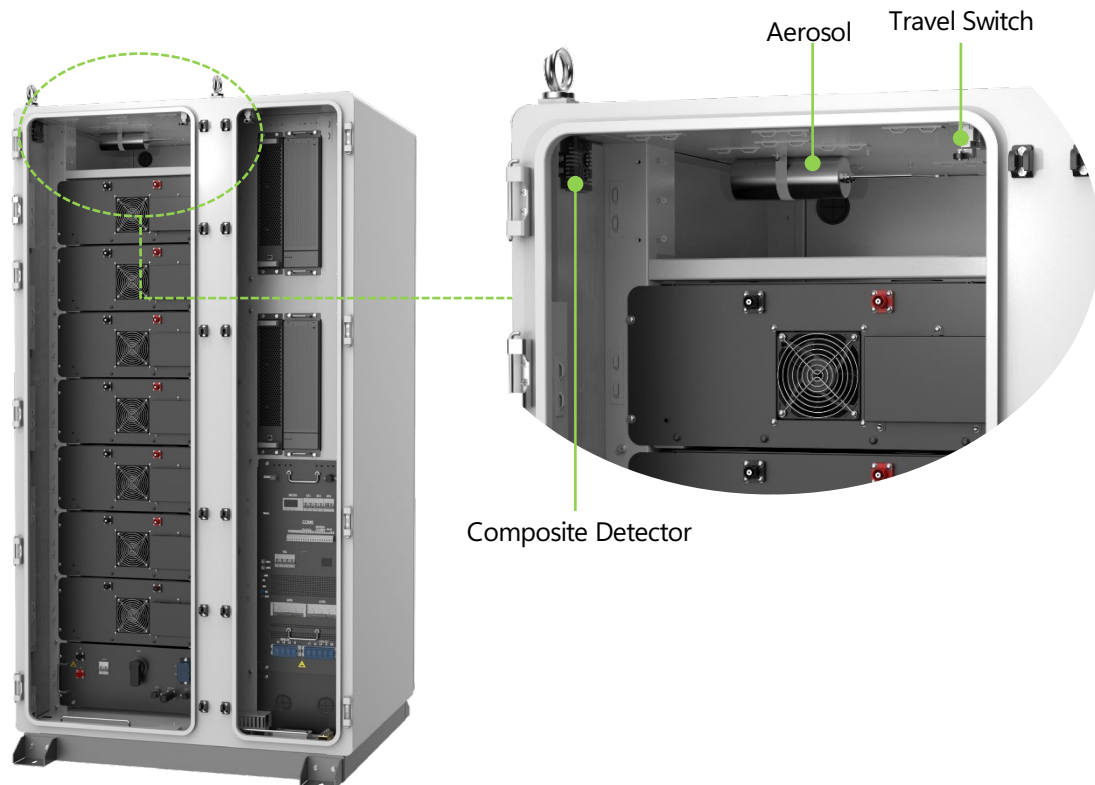

Figure 3-13 Security System

The maintenance of the fire protection system should comply with the fire regulations of the country/region where the project is located.

Fire protection equipment should be inspected and maintained regularly to ensure that all functional indicators are normal

4. Transportation And Storage

Caution: Failure to transport and store in accordance with the requirements of this manual may void the warranty.

4.1. Unpacking And Checking

- After receiving the product, please check whether all the delivered components are complete against the "supply list";
- Please check whether the actual received cabinet and the received product mode is the same as the ordered model;
- Carefully check whether the product is in good condition, the transportation process may lead to damage due to transportation collision, if any problem is found, please contact Dyness or the transportation company in time.

Shipping Requirement

- All necessary equipment in the product have been installed and fixed in the cabinet before leaving the factory, and the product can be transported as a whole during transportation.
- Please confirm that the cabinet doors of the equipment are tightly locked before transportation.
- The transportation of a single ESS cabinet requires wooden box Packaging, reserve buffer between the wooden box and ESS cabinet.
- Be sure to set up warning signs or caution tape to prevent unauthorized personnel from entering the lifting and transportation area to avoid accidents.
- Remove any existing or potential obstacles during the moving process, such as trees, cables, etc.
- Whenever possible, choose favorable weather conditions for transporting the equipment.

Requirements For Equipment Transportation Mobility

- Select a suitable crane or lifting tool according to the site conditions. The selected tool must have sufficient sufficient load-bearing capacity, arm length, and rotation radius.
- If movement on slopes or similar conditions is required, additional traction devices may be necessary.
- When carrying out ground transportation, be sure to use ropes to secure the top lifting ring of the equipment to the transport vehicle to prevent excessive tilting during transportation.

4.2. Lifting Transportation

This product is equipped with a lifting ring at the top for lifting, and can be transported by lifting. The following requirements must be met when lifting the products:

- Ensure site safety when lifting;
- When lifting and installing, professional personnel should be in charge of the whole process;

- The strength of the slings should be able to withstand the weight of the equipment;
- Ensure that all sling connections are safe and reliable, and ensure that each section of the sling connected to the corner piece is of equal length;
- The length of the slings can be adjusted appropriately according to the actual requirements of the site;
- Make sure that the equipment remains stable and does not tilt during lifting process;
- The equipment shall be suspended after being lifted from the ground by 300mm, and check that the lifting device is firmly connected before lifting.
- Take all necessary auxiliary measures to ensure safety.

Caution: The hanging rings need to be installed on site, please ensure that the hanging ring bolts are tightened before lifting.



Figure 4-1 Lifting Transportation

4.3. Forklift Transportation

The bottom of this product is equipped with fork holes specially designed for forklift transportation. The product can be moved through the bottom fork holes on the front and back. If the installation site is flat, the product can be moved using a forklift. Forklift transportation methods should meet the following requirements:

- The forklift should be equipped with sufficient load capacity;
- The length of the pins should meet the requirements of the equipment;
- The pins should be inserted into the fork holes at the bottom of the workstation;

- Moving and lowering should be slow and steady during forklift transportation;
- Products should only be placed on stable surfaces. The area should be well-drained, free of any obstacles or protrusions;
- Under no circumstances should the unit be moved by inserting the pins into a position other than the fork holes.

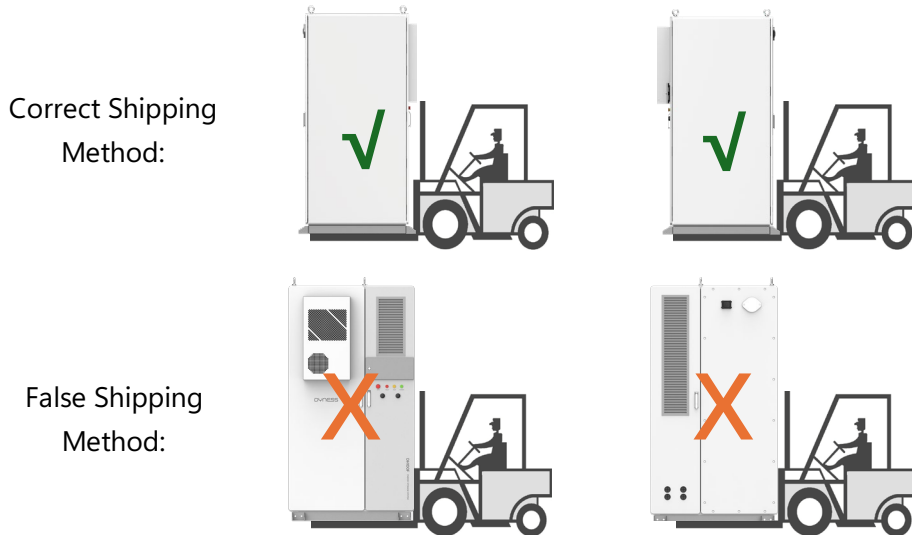

Figure 4-2 Forklift Transportation

4.4. Storage Requirement

Storage Environment Requirements

- The product should be stored on dry, flat (flatness should be no more than 5mm), solid ground with sufficient load-bearing capacity and without any vegetation cover;
- To prevent condensation inside the product or soaking of the bottom of the product during the rainy season, the product should be stored on higher ground.
- The basement must be raised, and the specific elevation height should be determined according to the site geology, meteorological conditions and other conditions.
- Storage environment temperature: 0~+35°C, humidity: 0~95%(no condensation).
- Pay attention to cope with the harsh environment around, such as sudden cold, sudden heat, collision, etc., so as not to cause damage to the PACK.

Storage Operating Requirements

- Packing boxes should not be tilted or inverted.
- Make sure that the cabinet doors are securely locked before storage.
- Effectively protect the product's air inlet/outlet to prevent rainwater, sand, and dust from entering the interior of the cabinet.
- Due to the capacity decay that occurs during long-term storage, it is not recommended to store batteries exceeding six months.
- For products stored for a long period (more than six months), inspecting visually before installation to ensure there is no condensation and verify if the equipment is intact. Additionally, checking after powering on.

- Perform regular inspections, more inspection programs please refer to chapter 9.



NOTE

Starting from the date of delivery, perform one charge and discharge cycle for the PACK every 6 months, to maintain the system SOC of 25~40%.

5. Installation

Only a qualified electrical engineer can operate related electrical connection. Please comply with the requirements given in "Safety Instructions" in chapter 2 and we shall not be liable for casualties or property loss caused by neglect of safety instructions.



DANGER

- Do not touch the live parts!
- Ensure both AC and DC sides are not energized before installation. All electrical connections must be operated under de-energized condition;
- Check the polarity of all input cables to ensure that each input polarity is correct before wiring;
- Do not place the equipment on surfaces that are flammable.



WARNING

- The ingress of sand and moisture may damage the electrical equipment inside the ESS cabinet or affect the performance of the equipment!
- During sandstorm seasons or when the relative environmental humidity exceeds 95%, electrical connection work should be avoided.
- Wait until there are no sandstorms and the weather is clear and dry before starting any connection work.
- Avoid pulling or tugging on cables or wires forcefully to prevent damage to their insulation performance during electrical installation.



CAUTION

- All cables and wires should be ensured to have a certain amount of bending space.
- Necessary auxiliary measures should be taken to reduce the stress on cables or wires.
- After completing each step of the wiring operation, careful inspection is required to ensure correct and secure connections.
- All electrical connections must be strictly in accordance with the wiring diagram.

5.1. Installation Environmental Requirements

Site Requirements

- When selecting the installation site, full consideration should be given to the surrounding environment (climate and geological conditions, such as stress wave emission, underground water level, no high cables in the vertical upper part of the installation site, no pipelines or other underground facilities in the lower part of the installation site, and a certain safety distance should be maintained between the equipment and buildings and people, the length of the distance should be subject to the fire safety regulations of the project).
- The surrounding environment should be dry and well ventilated.
- Please ensure that there are no trees around the installation location to prevent branches or leaves from blocking the doors or air inlets of the energy storage integrated system during strong winds.
- The installation location should be away from toxic and harmful gas and flammable, explosive, corrosive, and dust-intensive materials.
- The installation location should be away from residential areas to avoid noise.

Foundation Requirements

- The foundation should provide sufficient load-bearing support for the equipment.
- The height of the foundation should be higher than the historical highest flood level.
- The basic bearing capacity > 3t/m², the Basic service life > 50 years, and the basic level < 3mm/m².
- The ESS cabinet should be raised to against the rain. The recommended mounting height of the base is about 300mm-500mm higher than the ground.
- Drainage measures should be constructed according to local geological conditions.

Wiring Requirements

- According to the positions and dimensions of the cable inlets/outlets, sufficient space should be reserved for the AC side cable trough and the cable guide should be inserted in advance during foundation construction.
- The specifications and quantity of perforated pipes are based on the cable model and quantity of the cable.
- Both ends of all embedded pipes are temporarily sealed to avoid impurities from entering. Otherwise, later wiring is inconvenient.
- After connecting all the cables, inlets, outlets and connectors of the cable should be sealed with refractory clay or other suitable material to avoid entry of rodents.

5.2. Installation Spatial Requirements

The product adopts front-rear ventilation. Make sure that the equipment has enough space for better cooling and maintenance, it is advised to reserve enough space around the cabinet installation position.

The space reservation distance in front of the product is not less than 800mm.

The space reservation distance at the back of the product is not less than 600mm.

The space reservation distance of the left part of the product is not less than 500mm.

The space reservation distance of the right part of the product is not less than 300mm.



Figure 5-1 Single Product Dimension

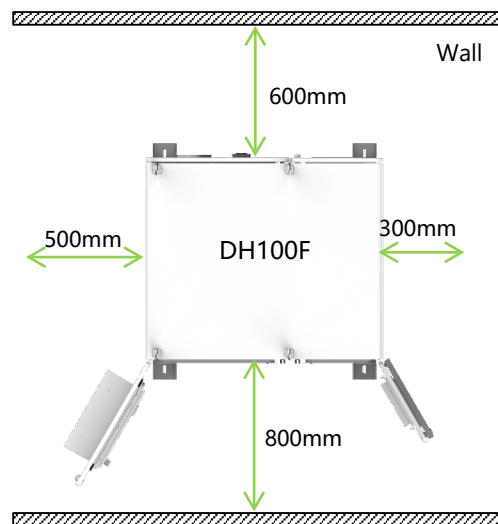
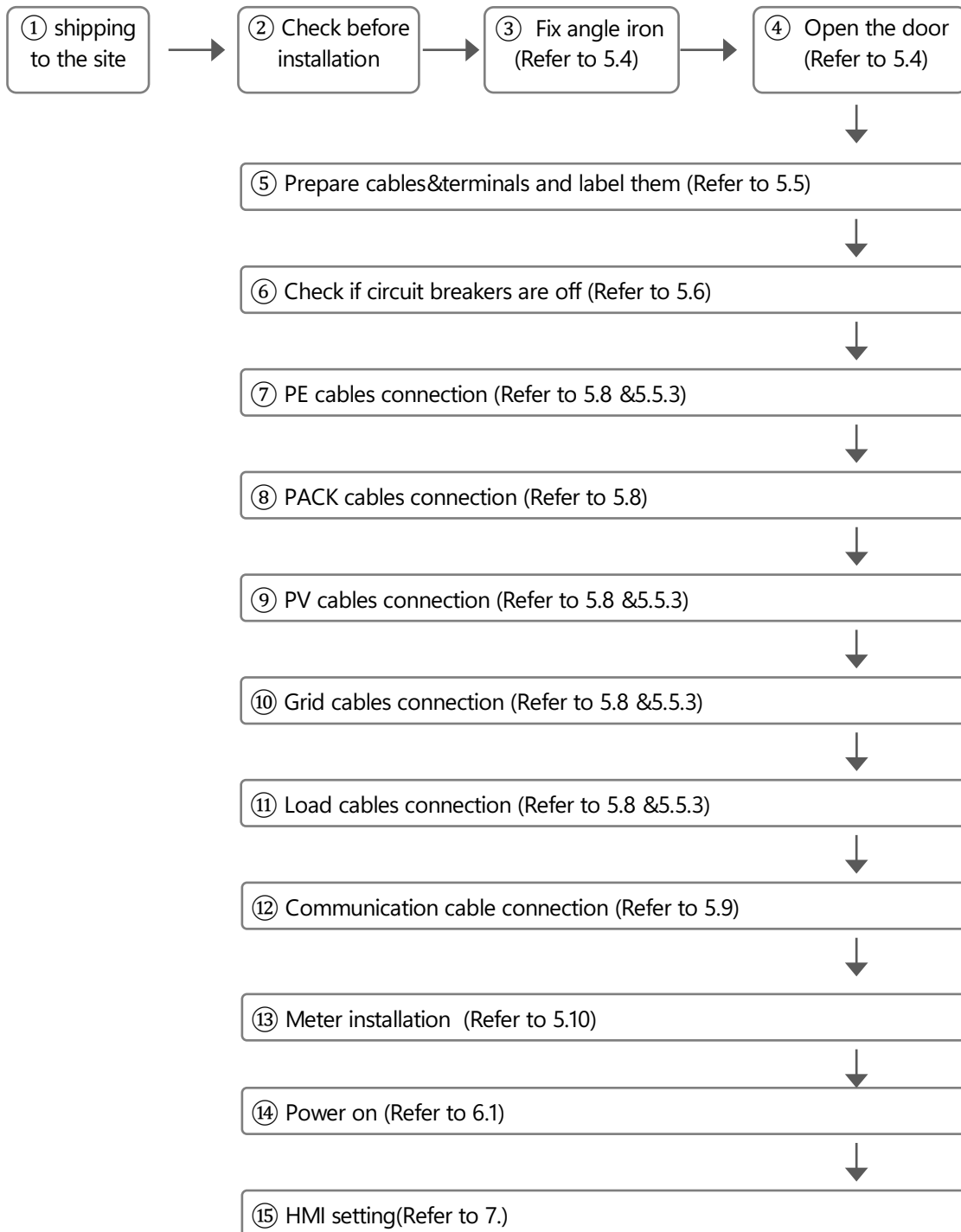

Figure 5-2 Single Product Installation

5.3. Installation Procedure

Product installation please follow the below steps, The specific operation process is detailed in this chapter.



5.4. Fixed Installation

Check Before Installation



WARNING

Please comply with local safety regulations and operational rules during installation. Only complete and undamaged equipment can be installed! Please ensure that before installation:

- The product cabinet itself should be complete and intact.
- All equipment in the cabinet should be complete and intact.

1. Install angle iron brackets and expansion bolts

The product adopts both bottom and rear cable outlet, concrete column is not necessary.

After shipping the product to the installation site, it shall be fixed. Four L-shaped angle iron brackets are pre-reserved at the front/back of the product base, as shown in the below diagram.

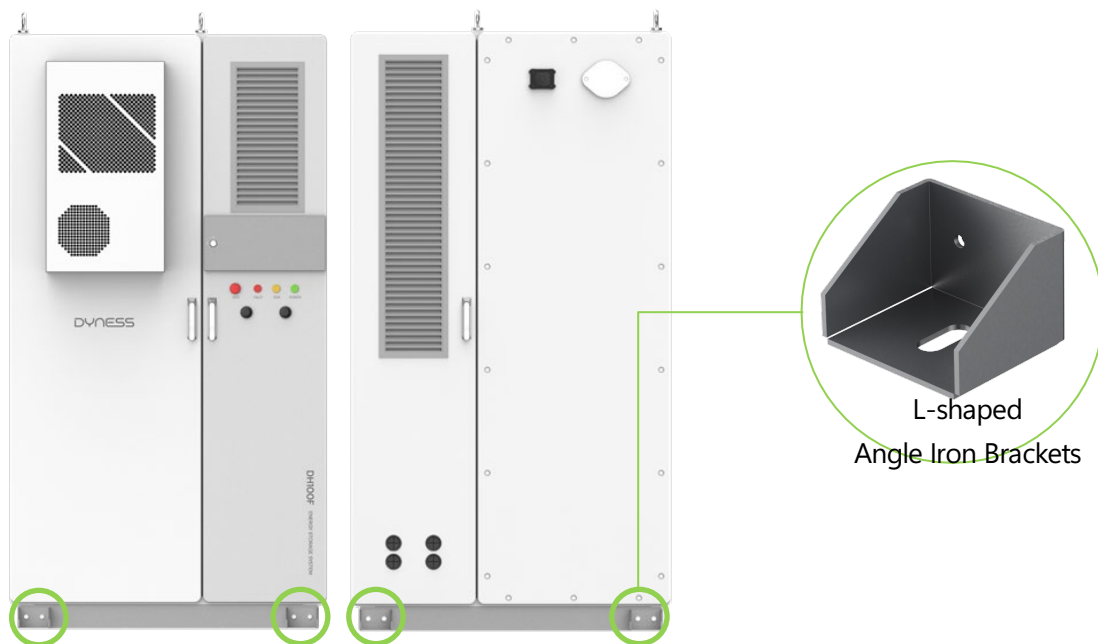

Figure 5-3 Angle Iron Brackets

The following tools may be needed for installing the brackets: marker pen, electric drill, angle iron, M12 expansion bolts. These tools are not included in the supply list and need to be provided by the customer.

L-shaped angle iron brackets installation steps

- ① Use a marker pen to mark the drilling positions.
- ② Choose an electric drill with a diameter matching the bolt's outer diameter, drill holes according to the bolt's length (hole depth slightly greater than the bolt length) until reaching

the desired depth for installation.

- ③ Insert the bolt and expansion sleeve into the hole, tighten the nut to the end of the bolt, and use a wrench to tighten it.

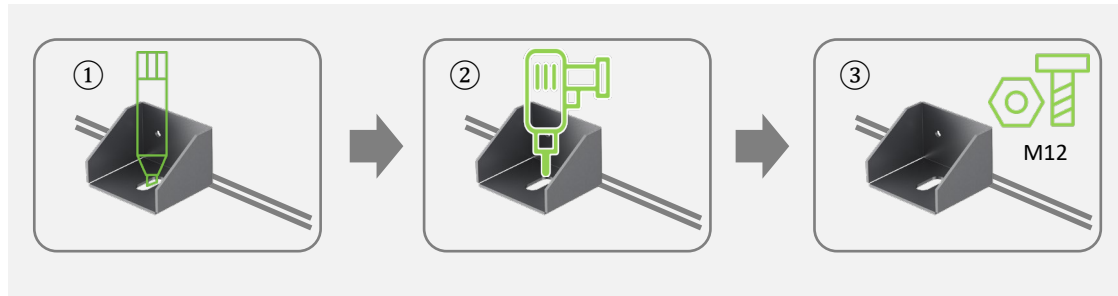

Figure 5-4 Angle Iron Brackets Installation Steps

Door Open Steps

- ① Make sure that the equipment is under lock state.
- ② Moving the lid up above the locking hole.
- ③ Getting the key in the door and revolve it clockwise.
- ④ Rotating the handle clockwise to the position shown in the figure to open the door.

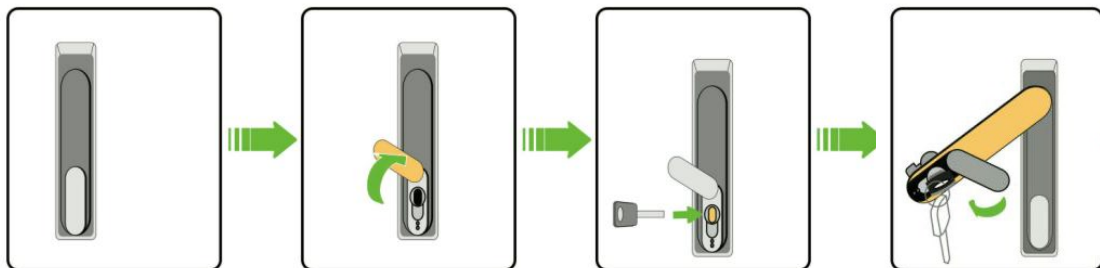

Figure 5-5 Door Open Steps

5.5. Preparation Before Installation

5.5.1. Wiring Tools

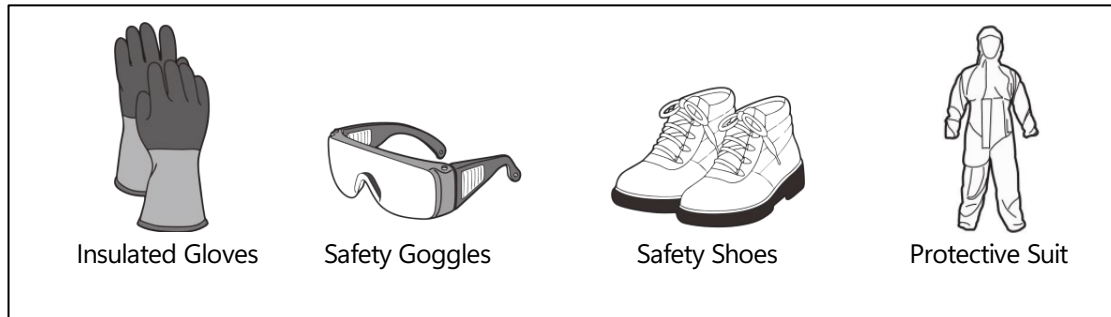

Figure 5-6 Safety Gear

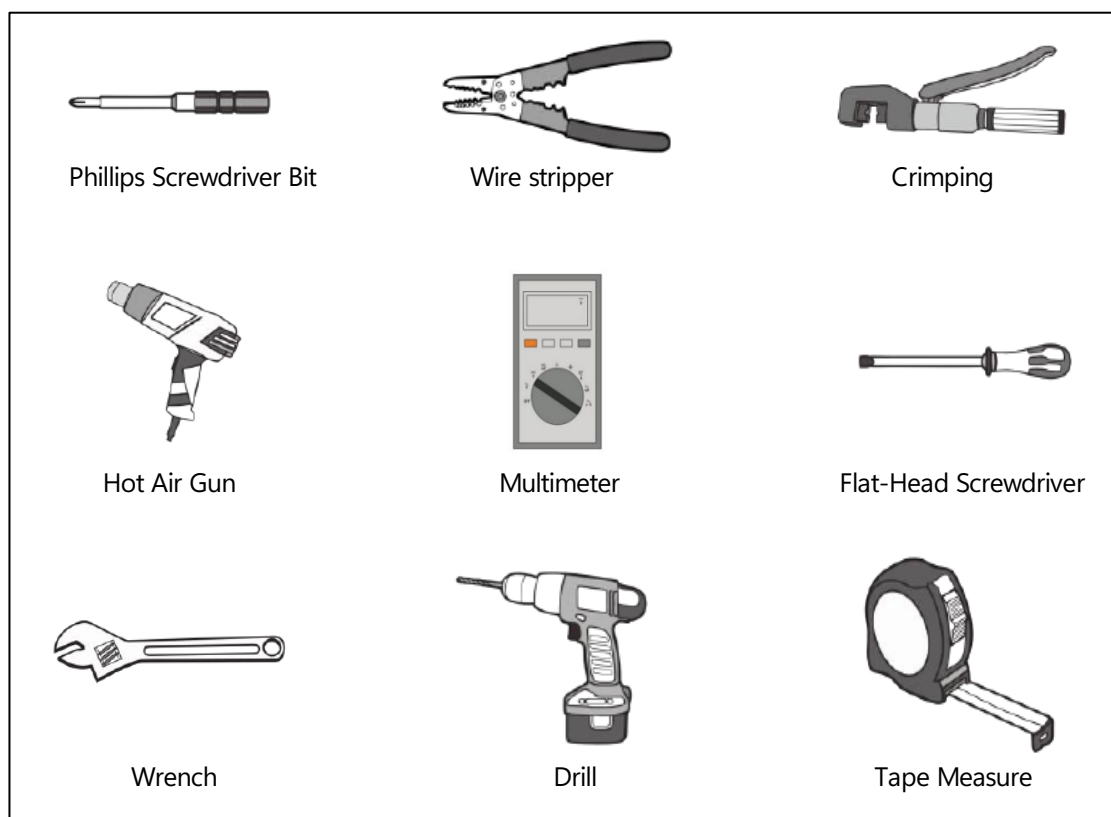

Figure 5-7 Tools







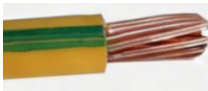

5.5.2. Wiring Accessories Requirements

Cable Requirements:

- Having sufficient current-carrying capacity. The cable diameter must satisfy the maximum current-carrying capacity, and the length must allow for a margin.
- The specifications and materials of three-phase AC output cables should be consistent.
- Be sure to choose flame-retardant cables.
- The cables used shall comply with the requirements of the local laws and regulations.

Notice: the following accessories need to be prepared by the customer.

Table 5-1 Wiring Accessories

NO.	Type	Function	Specifications	Qty	Notes
1	Power cable	Connect grid port Connect load port	Grid port: 4AWG Load port: 6AWG	As demand	
2	PE cable	Grounding cable	6AWG	As demand	
3	PV cable	Connect PV	4AWG	As demand	
4	Cable terminal	Copper terminal	DT/SC 25-6 DT/SC 16-6	As demand	
5	Control cable	For paralleling or connecting external devices (such as meter, PV, DG, etc.)	16AWG	As demand	
6	Sample cable	Anti-backflow meter voltage and current collection cables	Voltage: 16AWG Current: 14AWG	As demand	
7	Grounding bar	For grounding	40*4mm	As demand	
8	Primary transformer	Measure current value of primary circuit	0~5000A/5A	3	
9	Secondary transformer	Measure current value of secondary circuit	0~5A/0~20mA	3	

5.5.3. Terminal Wiring Method

OT/DT terminals connection step:

- (1) Peel off the insulation skin from the cable terminal, and the length of which should be the depth of the wire hole on the copper terminal, plus an additional 2-3mm.
- (2) Install the heat-shrink sleeve at the cable terminal and insert the exposed copper core part of the stripped wire into the wire hole of the copper terminal (OT/DT terminal).
- (3) Use hydraulic pliers to firmly crimp the copper terminal.
- (4) Slide the heat-shrink tube onto the copper terminal (OT/DT terminal) to fully cover the wire hole. Use a heat gun to tighten the heat-shrink tube.

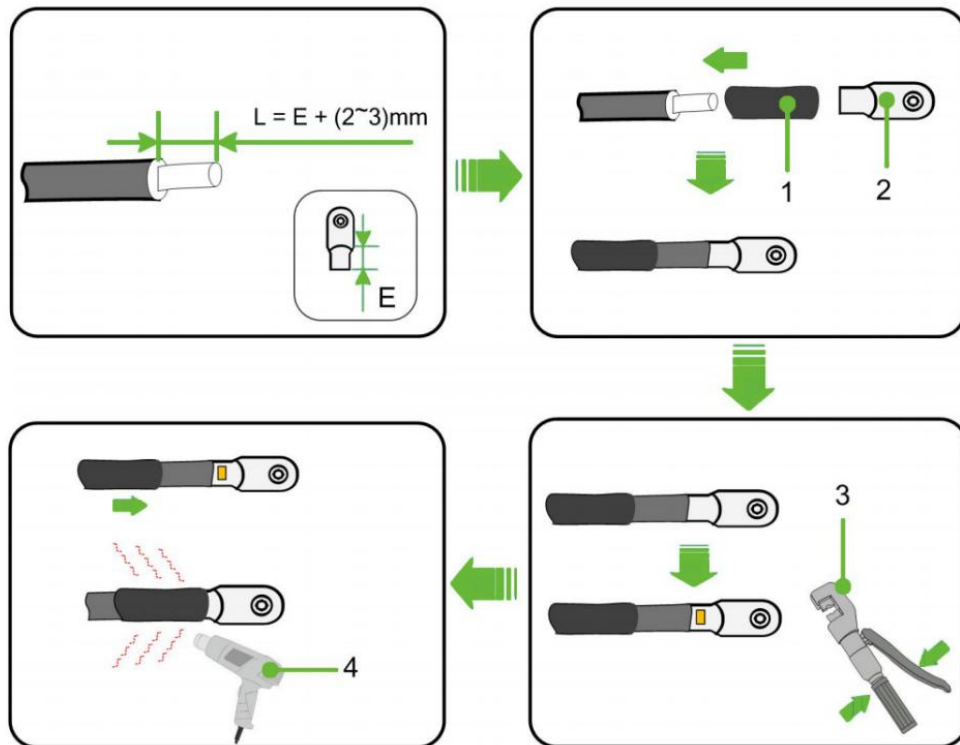

Figure 5-8 The Connection Sequence of Wiring Components

- 1: Heat-shrink tube
- 2: OT/DT terminal
- 3: Crimping Pliers
- 4: Hot air gun

5.6. Checking Before Wiring

1) Checking breakers

Check whether the next following circuit breakers is in the disconnected position.

- Secondary breaker (“QF4”) on the front panel of BDU (As shown in position 1);
- Battery breakers (“BAT”) on the front panel of BDU (As shown in position 2);
- Secondary breaker(“QF1”, “QF2”, “QF3”) on the front panel of distribution module (As shown in position 3);
- Grid breakers (“GRID”) on the front panel of distribution module (As shown in position 4);
- Load breakers (“LOAD”) on the front panel of distribution module (As shown in position 5);
- PV switches (“PV1”/ “PV2”) on the back panel of distribution module (As shown in position 6, if MPPT is not configured, there is no such switch.).

Note: The SPD switch (“FK1”) needs to be closed (As shown in position 7).

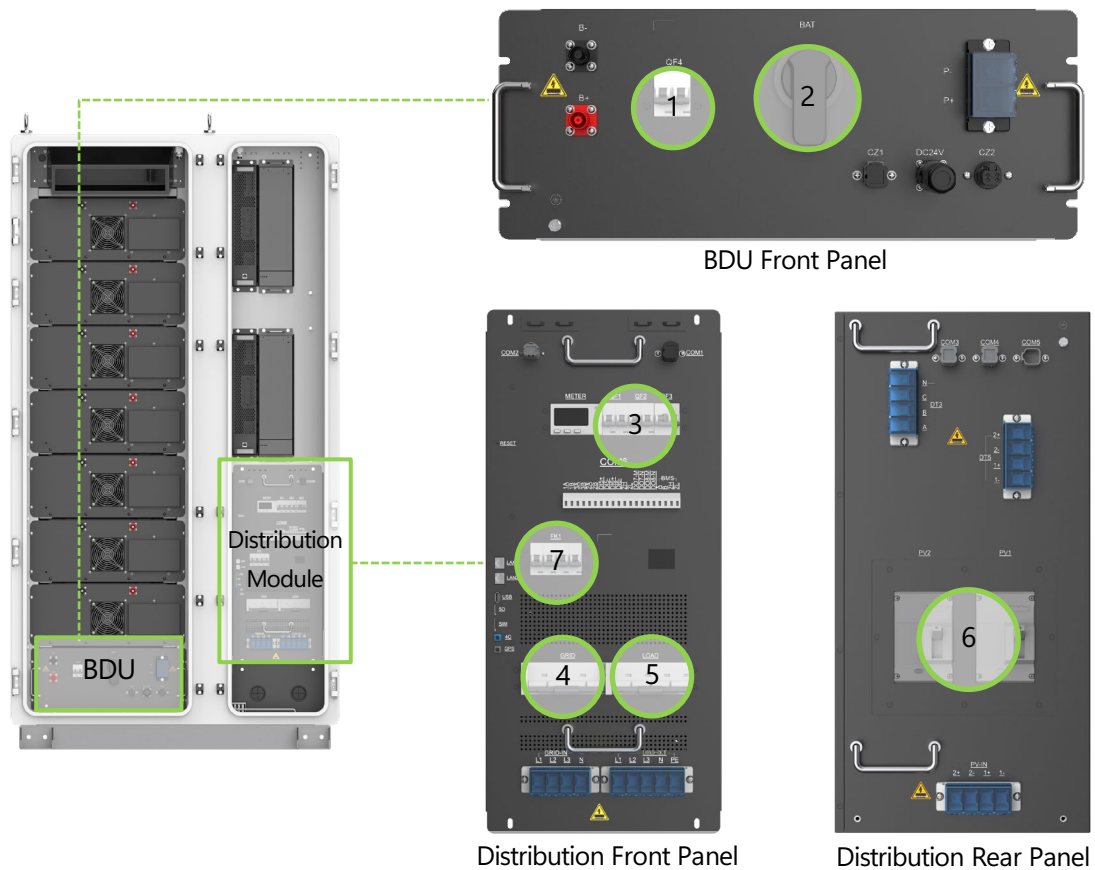

Figure 5-9 Breakers Location

2) Checking before wiring

Table 5-2 Checking List Before Wiring

No.	Checklist	Confirm
-----	-----------	---------

1	The cables and terminals used should meet the requirements of wire diameter and shielding	<input type="checkbox"/>
2	The cable are labeled correctly.	<input type="checkbox"/>
3	The related wiring accessories are ready.	<input type="checkbox"/>
4	The wiring operator have worn protective devices.	<input type="checkbox"/>
5	Checking if all the breakers are in disconnected position	<input type="checkbox"/>

5.7. Pe Wiring

The product is TN-S system, there are grid PE and load PE inside the product.

For off-grid applications, RCD (Residual Current Device) need to be installed at the off-grid port, with type AC being recommended.

The grounding connection must comply with local laws and regulation. Please consider the actual situation at project site and follow the instructions of the power station staff during the process of ground connection, the grounding connection is shown as follows:

- (1) Prepare **two PE cables(6AWG)**, label them as PE1 (Grid PE) and PE2 (Load PE);
- (2) The PE cables enter from the **inlet hole (as shown in position 1)** at the bottom of the electrical compartment ;
- (3) Connect PE1 cable to the **protective copper bar (as shown in position 2)**;
- (4) Connect PE2 cable to the **load PE port (as shown in position 2)**;
- (5) Grounding cables and terminal requirements should refer to 5.5.2;
- (6) Use **M6 bolt** to fix the DT terminals to the copper bar, terminal connections could refer to 5.5.3.

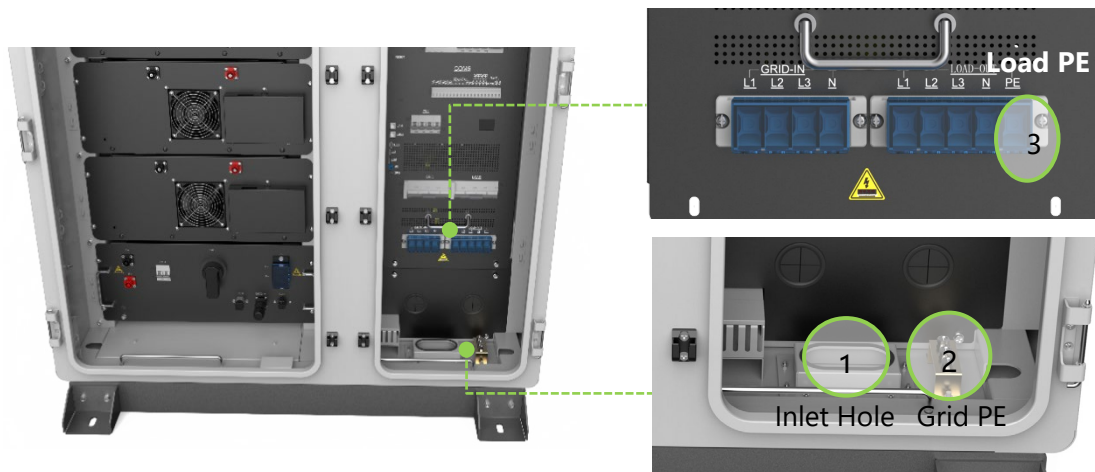

Figure 5-10 Grounding Step

After the grounding connection, the grounding resistance must be measured, and the specific grounding resistance value must comply with relevant region/local standards and regulations.

5.8. Electrical Wiring

Step 1: Battery Connection

To ensure the safety of the product, the power cables for the batteries are shipped with the product and need to be installed on-site as follows:

- (1) Please reconfirm the battery switch is off (as shown in position 1);
- (2) **PACK cables connections:** connect the PACKs in series with cables, where the negative terminal of the upper PACK is connected to the positive terminal of the lower PACK, please ensure the connection sequence is correct;
- (3) **PACK and BDU connection:** the positive terminal of PACK is connected to the positive terminal of BDU, the negative terminal of PACK is connected to the negative terminal of BDU.

Notice : the color of PACK and BDU terminals: red represents positive, black represent negative.

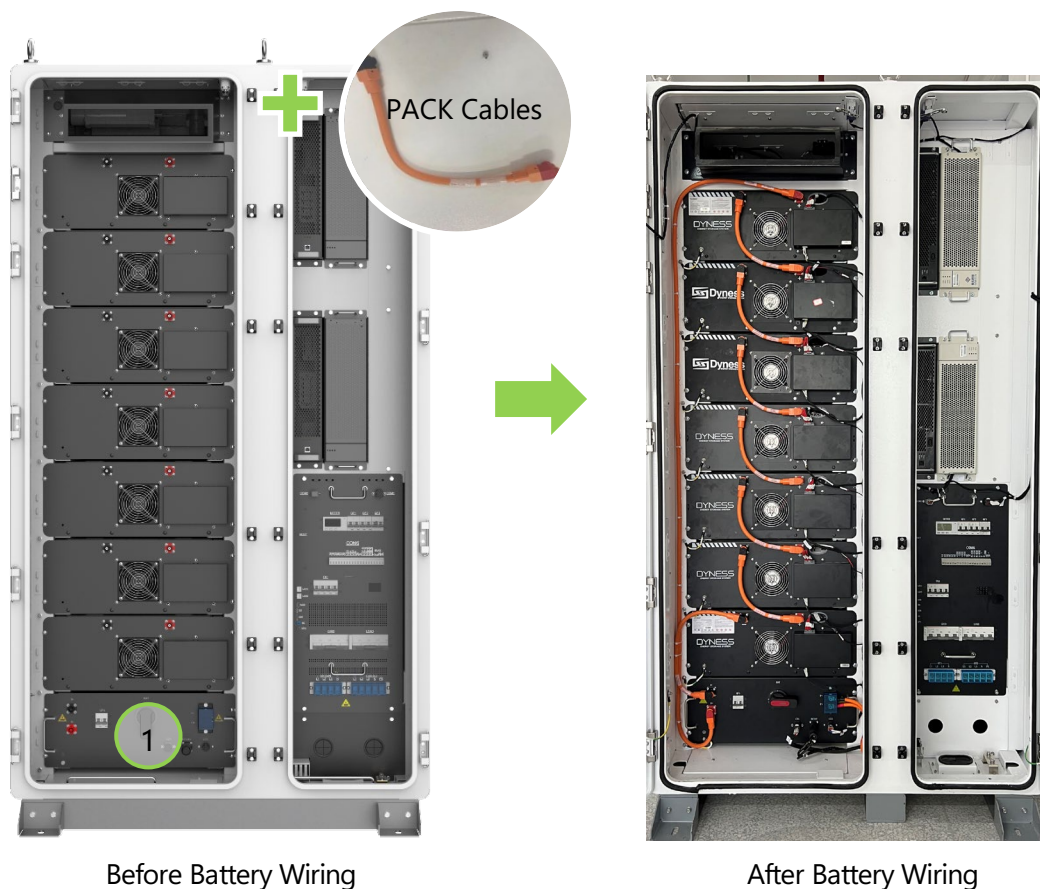

Figure 5-11 Battery Connections

Step 2: PV Connections

The product that is equipped with MPPT module, it need to connect the PV cables (4AWG), please skip this step without MPPT.

- (1) Please reconfirm the PV switches ("PV1" and "PV2") are off (as shown in position 1), and measure with DC setting of multimeter to make sure there is no voltage;

- (2) Guide the PV cables into the rear electrical compartment through the inlet hole (as shown in position 2);
- (3) Bring the PV cables to the connection area that labeled "PV-IN" (as shown in position 3), make sure the PV cable are connected in correct sequence;
 - 1+/1- represents the positive/negative connection of PV1;
 - 2+/2- represents the positive/negative connection of PV2.
- (4) After completing the connections, gently tug on the cables to ensure there is enough slack.

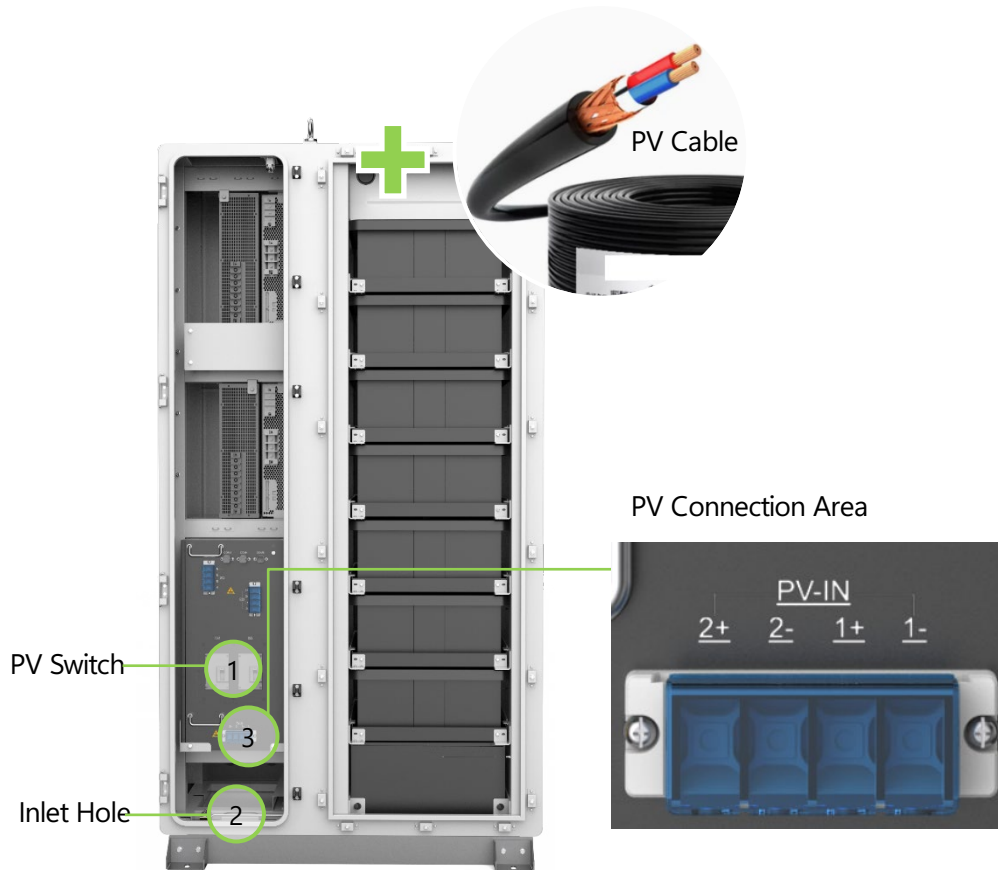

Figure 5-12 PV Connection Step

Step 3: Grid Connections

- (1) Please reconfirm the grid switch (labeled "GRID") are off (as shown in position 1), and measure with AC setting of multimeter to make sure there is no voltage;
- (2) Guide the Grid cables(4AWG) into the front electrical compartment through the inlet hole (as shown in position 2);
- (3) Bring the grid cables to the connection are that labeled "GRID-IN"(as shown in position 3), make sure the cables L1, L2, L3, N are connected in correct sequence;
- (4) Use M6 bolt to fix the terminals;
- (5) After completing the connections, gently tug on the cables to ensure there is enough slack.

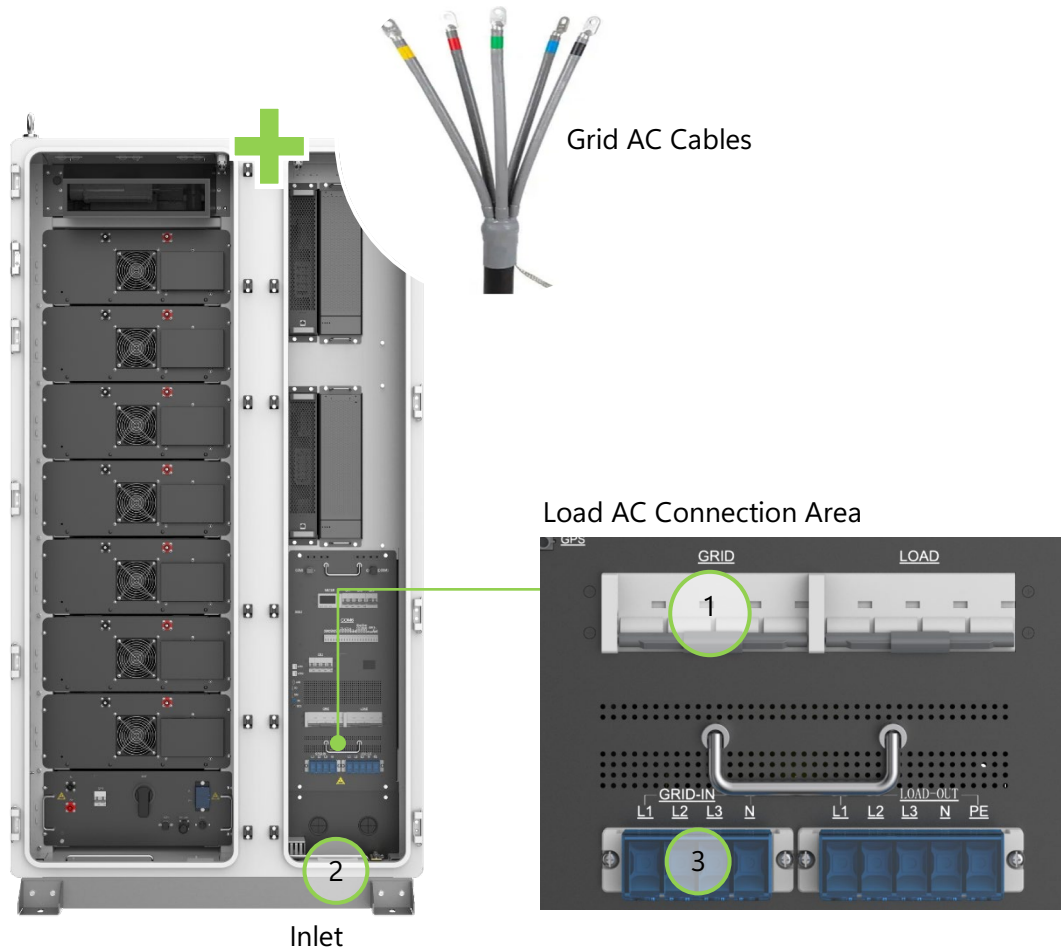

Figure 5-13 Grid Connection Step

Step 4: Load Connections

- (1) Please reconfirm the Load switch (labeled "LOAD") are off (as shown in position 1), and measure with AC setting of multimeter to make sure there is no voltage;

- (2) Guide the Load cables(6AWG) into the front electrical compartment through the inlet hole (as shown in position 2);
- (3) Bring the load cables to the connection are that labeled "LOAD-IN" (as shown in position 3), make sure the cables L1, L2, L3, N are connected in correct sequence;
- (4) Use M6 bolt to fix the terminals;
- (5) After completing the connections, gently tug on the cables to ensure there is enough slack.

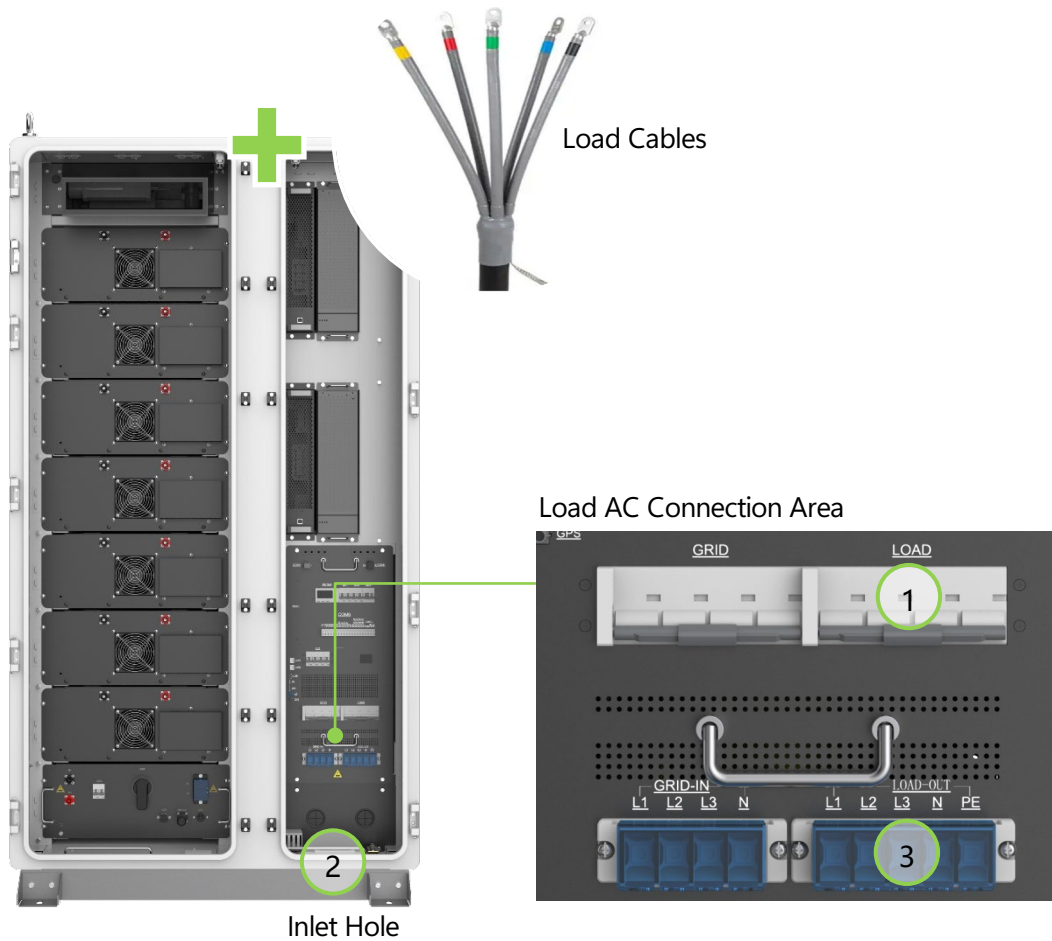

Figure 5-14 Load Connection Step

5.9. Communication Wiring

The EMS is incorporated inside distribution module;

The product is adjustable to multiple protocol, it has multiple external communication ports:

LAN, USB, CAN, 4G, GPS, SD, SIM card;

Be sure to use correct communication cables (18AWG recommended).

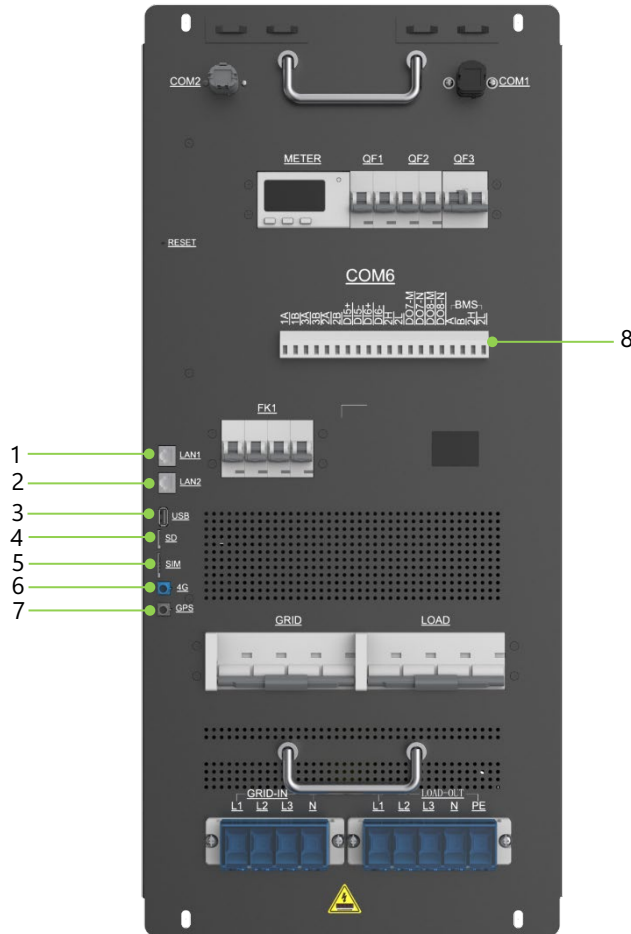

Figure 5-15 Communication Port

Table 5-3 Communication Port Definition

No.	Label	Definition
1	LAN1	LAN port 1 for connecting Ethernet and local host computer
2	LAN2	LAN port 2 for connecting Ethernet and local host computer
3	USB	USB port, for EMS local program upgrade
4	SD	SD card port, for local data storage
5	SIM	SIM card port
6	4G	4G antenna port
7	GPS	GPS antenna port
8	COM 6	External communication port

5.10. Meter Installation

There are system meter inside the product and anti-backflow meter outside the product.

System Meter

The system meter is installed inside the distribution module and it is for reading charge/discharge data from the system.

Anti-Backflow Meter

Anti-backflow functions: detect if there is current flow to the grid, if it does, it will send information to EMS which will respond to it and limits the PV output.

The anti-backflow meter need to be installed at the grid side.

There are two type of anti-backflow meters: primary meter (ADL400-C) and secondary meter(DTSD1352), both of them are provided by Dyness. Customers can choose either one based on their usage requirements. Current transformer need to be provided by users themselves, the specifications should refer to 5.5.2.

- Type of primary meter: ADL400-C
- Type of secondary meter: DTSD1352

Anti-Backflow Meter Connection

- (1) CT direction: the current flow through the CT should be P1 → P2, which means the current flows from the grid to the load;
- (2) Meter voltage sampling connection: Connect the Ua, Ub, Uc, and N terminals of the meter to the incoming terminals of the transformer. Ensure that the phase sequence (A/B/C/N) connections are correct. The voltage sampling wire diameter must be at least 16AWG, and the wire withstand voltage rating must meet AC450V.
- (3) External Connection of the Meter with CT: Connect the red wire to Ia*, Ib*, Ic* on the meter, and the black wire to Ia, Ib, Ic on the meter. The current connections are as follows:
 - Ia* ↔ Ta(S1), Ia ↔ Ta(S2)
 - Ib* ↔ Tb(S1), Ib ↔ Tb(S2)
 - Ic* ↔ Tc(S1), Ic ↔ Tc(S2)
- (4) External transformers must be grounded;
- (5) The meter communicate with DH100F through RS485, connect the meter to the port labeled "3A/3B" of COM6 on the distribution module.

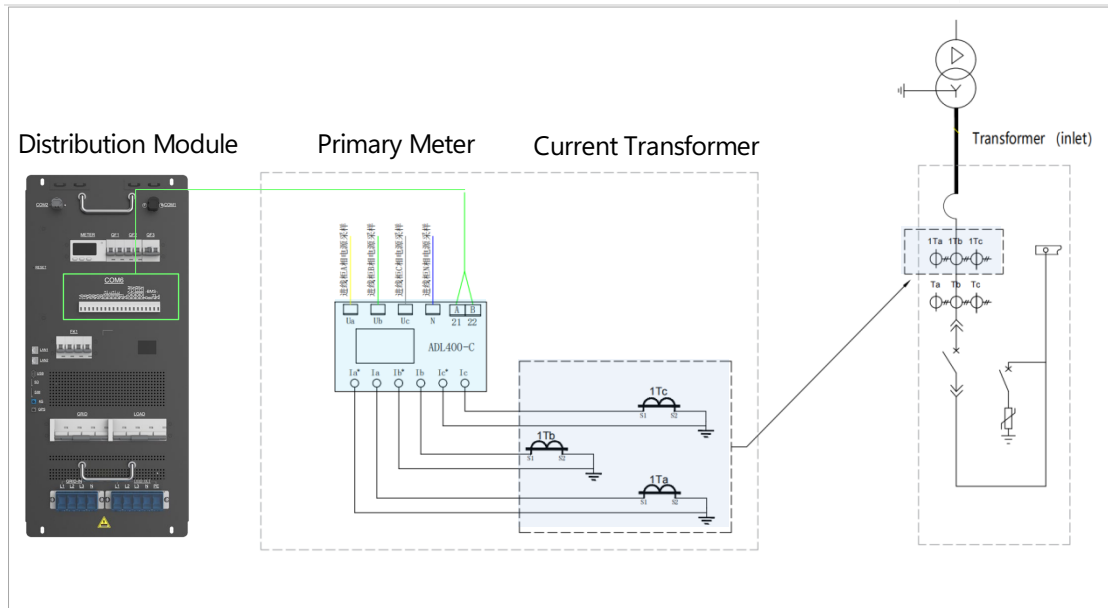

Figure 5-16 Primary Meter Installation

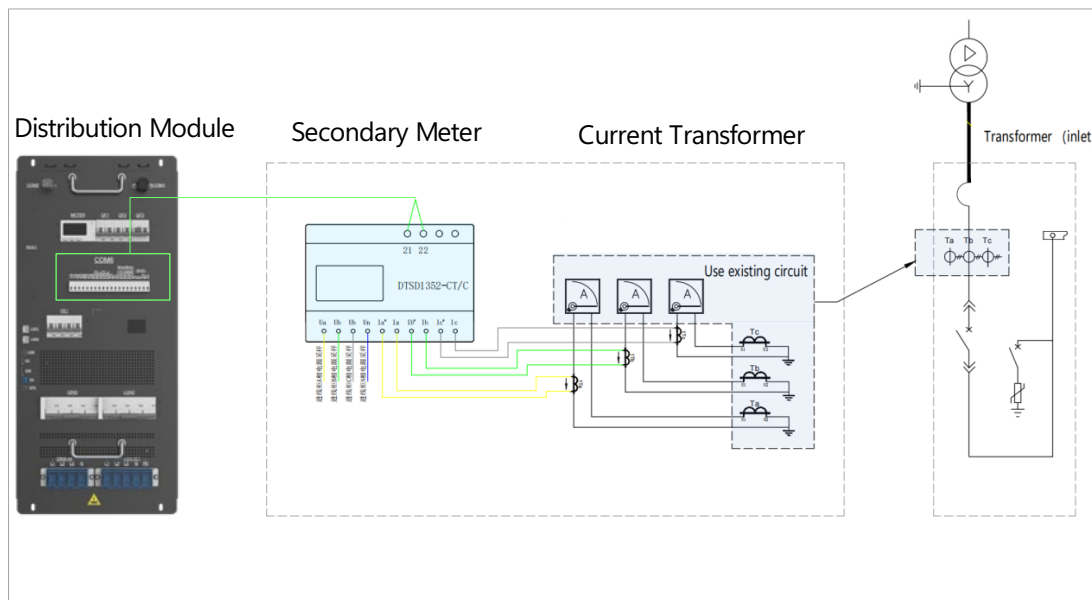

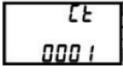

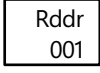

Figure 5-17 Secondary Meter Installation

Notice:

- DTSD1352 is equipped with mA level transformer, it is strictly prohibited to access to 5A or 1A output transformer, which may damage the meter;
- When connect DTSD1352 meter, it is forbidden to short-circuit or ground the terminals of the current transformer, as this may result in inaccurate measurements or meter damage.
- When using DTSD1352 to measure the secondary lines of an on-site current transformer, ensure that the built-in transformer is kept at a distance of more than 30cm from the on-site primary transformer to avoid interference in the readings.

Meter Debugging:

The meter debugging can only be set after power on. Product power on please refer to 6.1.

- (1) Set current ratio: , the current ratio is set based on actual conditions, e.g. if the ratio is 200:5, set it to 0040.
- (2) Confirm wiring configuration: ;
- (3) Set communication address: set system meter address to , set anti-backflow meter address to .

Notice: after completing the set-up, when drawing power from the grid, the meter reading will show "+", and when feeding power back into the grid, the meter reading will show "-".

5.11. Checking After Wiring

Please check the following checklist after wiring to avoid equipment damage.

Table 5-4 Checklist Bfore Wring

NO.	Checklist	Confirm
1	Disconnect the battery switch and grid battery before measuring, please ensure the AC side and DC side of PCS ARE not energized.	<input type="checkbox"/>
2	Please check if the negative and positive connection between battery-DC/DC-PCS, the AC phase of PCS are connected correct. Measure the resistance between the three phase, which should be in the MΩ level, if it is in kΩ level or smaller, please check the circuit.	<input type="checkbox"/>
3	Check if External cables, PE cables and communication cables are well connected.	<input type="checkbox"/>
4	The PE cable resistance should be less than 0.1Ω;	<input type="checkbox"/>
5	Clean the installation area and ensure that there are no tools or other unrelevant objects left inside the ESS cabinet.	<input type="checkbox"/>
6	Use fireproof and waterproof materials to tightly seal the openings and gaps around the ESS cabinet's entry and exit holes.	<input type="checkbox"/>

6. Power On and Power Off

6.1. Power On Process

Precautions:

- The product can only be put into operation after being confirmed by professionals and approved by the local power department.
- For products with a long shutdown time, before powering on, a comprehensive and detailed inspection must be carried out on the equipment to ensure that all indicators meet the requirements before powering on.

Check before power on

Table 6-1 checklist before power on

NO.	Checklist	Confirm
1	Check if the wiring is correct;	<input type="checkbox"/>
2	Check if the emergency stop button is released;	<input type="checkbox"/>
3	Check if the SPD switch(FK1) in closed state;	<input type="checkbox"/>
4	Check PE cable connection to make sure there are no ground faults;	<input type="checkbox"/>
5	Check if the AC and DC voltages meet the start-up conditions and there is no risk of over-voltage with multimeter;	<input type="checkbox"/>
6	Check to make sure no tools or parts are left inside the device;	<input type="checkbox"/>
7	Check if there is condensation, if so, must open the ESS cabinet for ventilation until condensation disappears;	<input type="checkbox"/>
8	Check if the air conditioner in normal state and no abnormal sound;	<input type="checkbox"/>
9	Check if there are no wire ends, metal shavings and other objects that may cause short circuits in signal or power cables.	<input type="checkbox"/>

Power on steps (Grid—Battery—PV—Load)

Step 1: Close the "GRID" grid circuit breaker on the front panel of the distribution module;

Step 2: Close the "BAT" battery circuit breaker on the BDU;

Step 3: Close the "QF4" secondary circuit breaker on the BDU;

Step 4: Close the "QF1" and "QF2" secondary circuit breakers on the front panel of the power distribution module;

Step 5: Close "PV1" and "PV2" photovoltaic disconnect switches on the rear panel of the power distribution module in turn (this step can be skipped if the MPPT module is not configured);

Step 6: Close the "LOAD" load circuit breaker on the front panel of the power distribution module;

Step 7: Set the EMS operation mode according to the application, and make the EMS work in automatic mode after setting. For specific operations, please refer to chapter 7 "HMI operation".

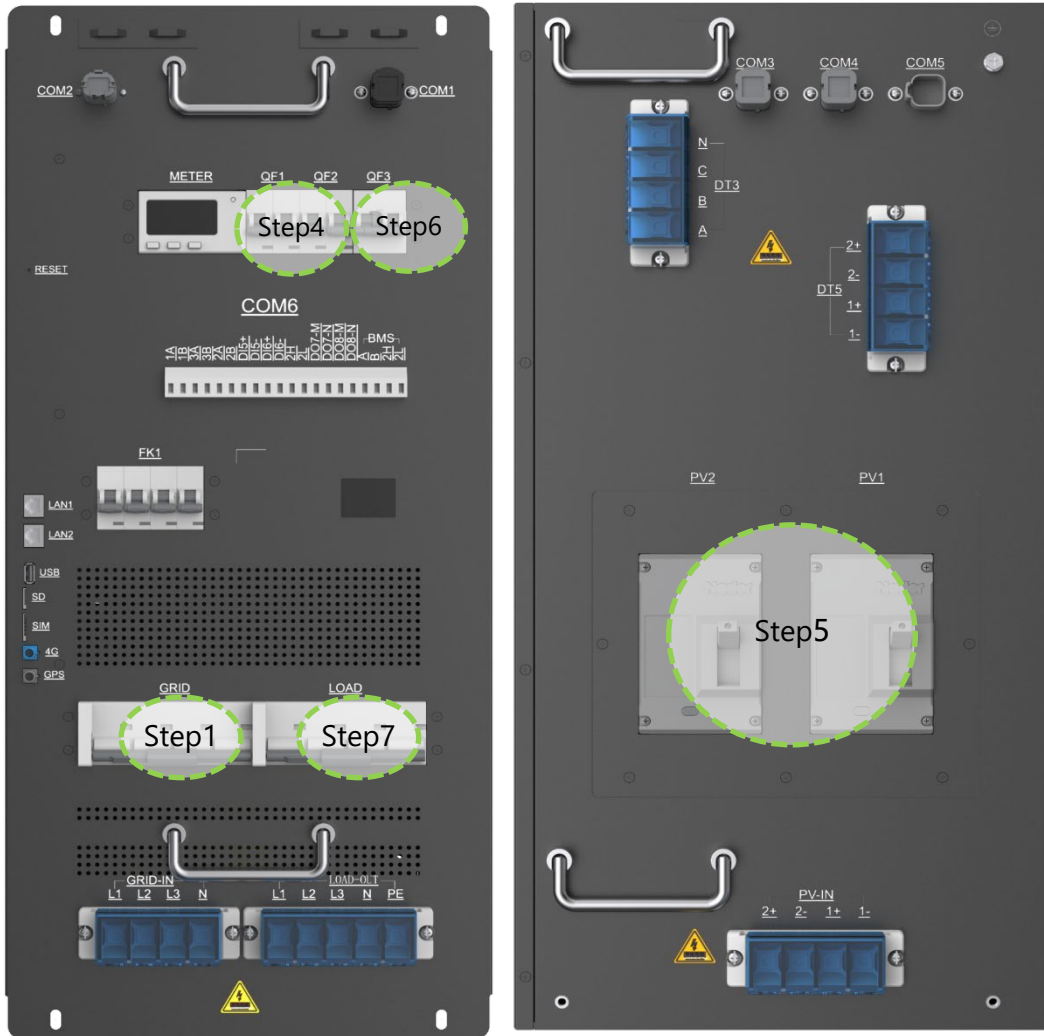

Distribution Module Front Panel

Distribution Module Rear Panel

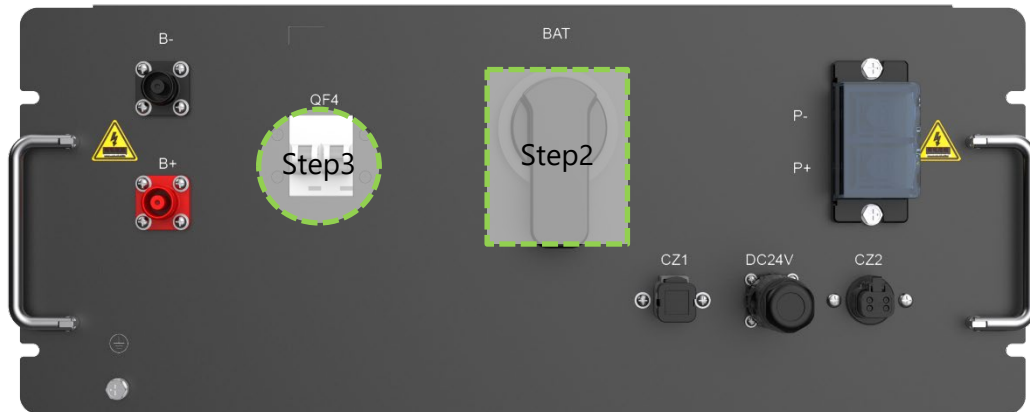

BDU Schematic

Figure 6-1 Power-on Operation

After operating the steps one by one, check whether the indicator light of the product is on and whether the screen is displayed. If the product status is normal, the "POWER" and "RUN" indicator light are on, and "FAULT" indicator is off. The screen starts to display the system running status and parameters.

6.2. Power Off Process

Operation process could refer to the above image (Load—PV—Battery—Grid)

Step 1: Stop the system through the HMI screen or host computer;

Step 2: Disconnect the "LOAD" load circuit breaker;

Step 3: Disconnect "PV1" and "PV2" photovoltaic disconnect switches in turn;

Step 4: Disconnect "QF1" and "QF2" secondary electric circuit breakers in turn;

Step 5: Disconnect "QF4" secondary electric circuit breaker;

Step 6: Disconnect the "BAT" battery circuit breaker;

Step 7: Disconnect the "GRID" grid circuit breaker.



WARNING

After operating step by step, the system will stop running, and the product indicators and screen will go out. After the inspection is completed, wait for five minutes to perform maintenance and inspection operations.

6.3. Emergency Stop

Press the "EPO" red button on the front door when there is an emergency.

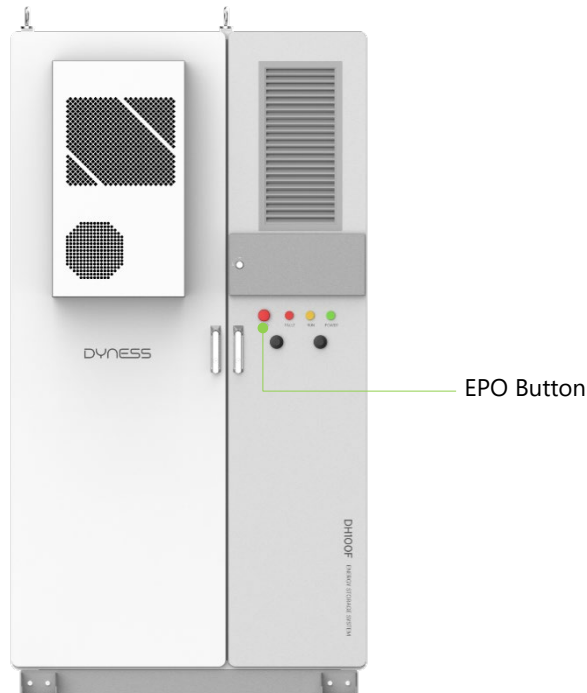

Figure 6-2 EPO Location

**WARNING**

Under normal circumstances, please use the normal shutdown procedure to power off the product! In emergency situations, it is necessary to use EPO to ensure quick response and protect personal and equipment safety!

7. HMI Operation

7.1. Main Functions

7.1.1. Automatic Mode

The system EMS accept command from the system HMI and Dyness cloud platform to execute the following modes.

(1) Anti-backflow function

For application where PV is not allowed to feed the grid, EMS will control PV output supply the load first, and store excess PV energy to ESS. When neither ESS nor loads can consume the excess PV energy, it will limit PV output to prevent PV feeding the grid.

(2) Transformer protection function

Grid-side transformer protection enable, transformer protection power can be set, real-time detection of transformer-side power through the anti-reverse current meter, adjusting the charging and discharging power of the energy storage system, to avoid the transformer-side power exceeding the protection limit value.

(3) Scheduled mode

The "Scheduled mode" can be set to "Any Periods" or "48 Periods" (24 hours divided into 48 segments).

【Any periods】

- Allows the system to select periods by month (1~4), with up to 4 sets of time periods possible (Period One, Period Two, Period Three, Period Four).
- The system operates for 7 days (Monday to Sunday), with each day having up to 10 periods, and each period can be preset with the corresponding mode.
- Once set, the system operates according to this schedule.

【48 periods】

- Allows the system to select periods by month (1~4), with up to 4 sets of time periods possible (Period One, Period Two, Period Three, Period Four).
- The system can divide each day into 48 time periods, and each period can be preset with the corresponding mode.
- Once set, the system operates according to this schedule.

(4) Peak shaving

Based on user's electricity consumption pattern, peak value and valley value are set to reduce peaks loads and fill in low-load valleys, so as to balance the power generation and consumption.

The PV maximize its output under this mode, if the system enables anti-backflow function, then it will limit PV output when it triggers anti-backflow function.

- When $P_{grid} > P_{peak\ value}$, the ESS start discharging;
- When $P_{grid} < P_{valley\ value}$, the ESS start charging.

(5) Self-Consumption

known as PCC (Point of Common Coupling) power control mode, users can set the power value at the PCC point, and the system controls the power at the PCC point to remain stable at the set value.

- When $P_{PV} > P_{load}$, the PV output cannot be fully consumed by loads, the ESS start charging;
- When $P_{PV} < P_{load}$, the PV output is insufficient to feed loads, the ESS start discharging.

7.1.2. Remote Mode

System only accepts commands from external EMS which could control the system through the EMS of this product.

7.2. Operation System Overview

The product is equipped with 7-inch screen, on where the users could check the system information and set system parameters.

Table 7-1 HMI Interface Overview

Main window	Main menu	Level 1 sub-menu	Level 2 sub-menu	Level 3 sub-menu	
Main interface	Dashboard	Grid			
		AC/DC			
		Battery			
		Load			
		PV			
	Data	EMS		Status	
				Parallel	
				INV/CHG data	
				S-P-F-V data	
		AC/DC		Basic data	
				Alarm data	
		DC/DC		Basic data	
				Alarm data	
		MPPT		Basic data	
				Alarm data	
		BMS data		Basic data	
				Cell voltage data	
				Temperature data	
				Alarm data	
		Sys data		Meter	
				FFS	
				Air-conditioner	
	Alarm Info		Alarm		
			History		
	Version Info				
	Setting	EMS	Runset	Automatic mode	
				Remote mode	
			DataSet	SysParam	
	Login	Permission			
			Modify		

Please notice: the HMI interface may vary with version update, the images in this chapter is only for reference.

HMI main interface

Language setting: At the upper right of main interface, user could select display language;

- **Dashboard:** display the details of system access device;
- **Data:** query the detailed data, alarm information, version information of each sub-module of the system;
- **Setting:** setting the related system parameters (please notice the user could only change the EMS parameters);
- **Login:** the permission for login the system.

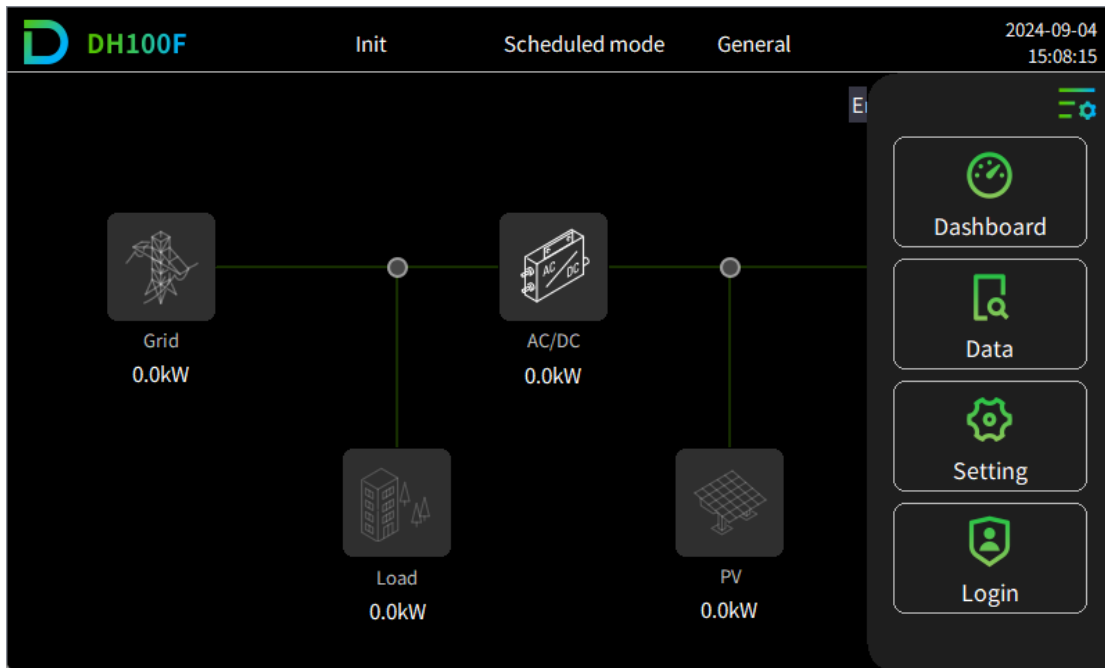



Figure 7-1 HMI Main Interface (Image Only For Reference)

7.3. User Login

Table 7-2 Login Permission Description

Permission	Description
Not login	When not log in, the user could only read the system running data, cannot set the device.
General user	The user could check the system running data and set related system parameters. This permission is only open to on-site installation personnel, the original password is 1111.
Advanced user	Only open to the manufacturer staff.

Login step

- Step 1: Click **main menu icon**  on the upper right corner of the main interface;
- Step 2: Click **"Login"** to enter the user interface under the main menu bar;
- Step 3: Select **"General"**, input password(1111), click **"Login"**;
- Step 4: Click **"Confirm"** in the prompt popup.

-- END



Figure 7-2 General User Login Step

Change password

- Step 1: Click "**Modify**" at the upper left of navigation bar;
- Step 2: Input old password and new password, complete the setting, then click "**Confirm modification**";

-- END

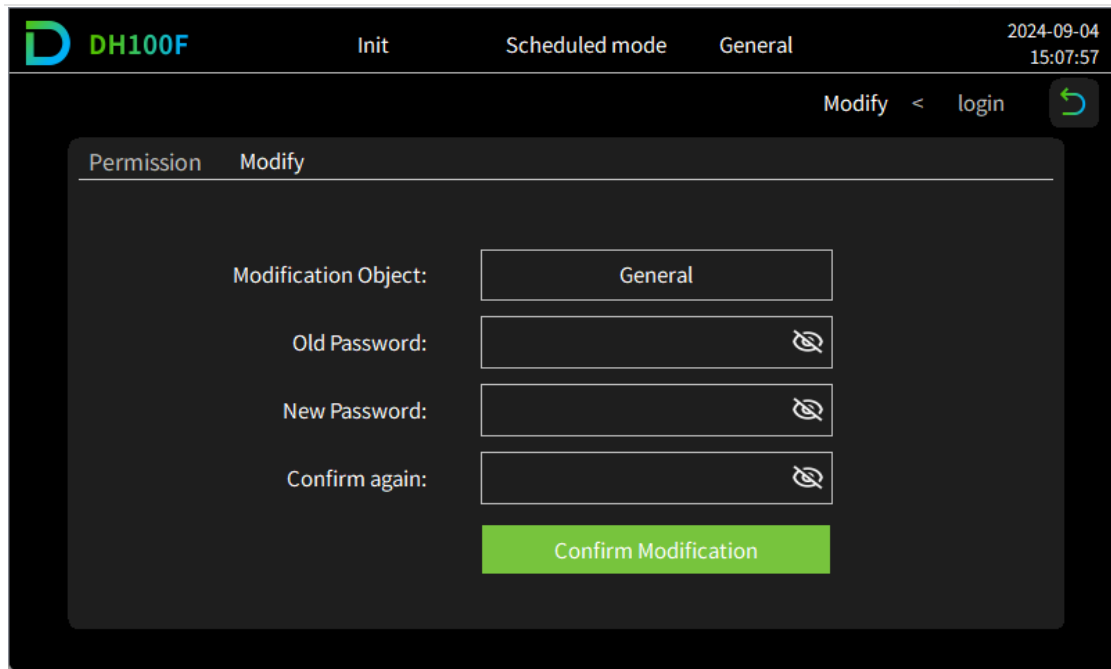







Figure 7-3 Change Password Diagram

7.4. Running Information

Method 1

Click corresponding icons on the main interface and directly enter corresponding module data interface.

- Click Grid icon , enter Grid interface;
- Click Load icon , enter Load interface;
- Click AC/DC icon , enter AC/DC interface;
- Click Battery icon , enter Battery interface;
- Click PV icon , enter PV interface.

Method 2

- Step 1: Click **main menu icon**  on the upper right corner of the main interface;
- Step 2: Click **"Dashboard"** under main menu bar;
- Step 3: Select corresponding sub-menu (**Grid/ AC/DC / Battery / Load/ PV**) as needed.

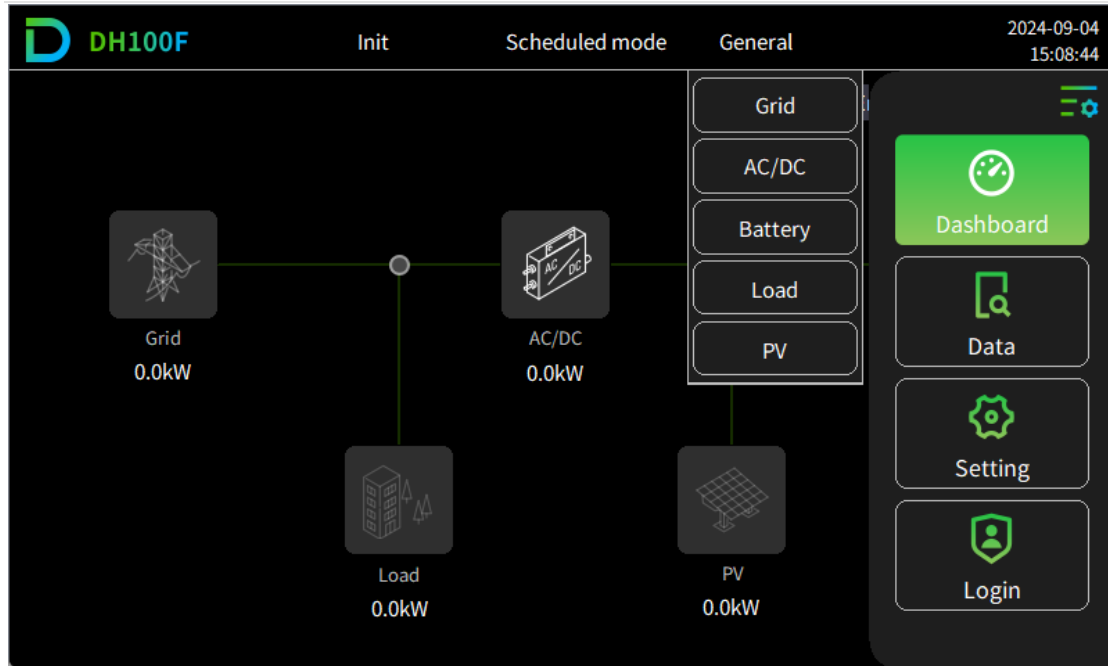



Figure 7-4 System Running Information Overview (Image Only For Reference)

7.5. Query Data

- Step 1: Click [main menu icon](#)  on the upper right corner of the main interface;
- Step 2: Click ["Data"](#) under main menu bar;
- Step 3: Select corresponding sub-menu ([EMS](#) / [AC/DC](#) / [MPPT](#) / [BMS data](#) / [Sys data](#) / [Alarm Info](#) / [Version Info](#)) as needed.

-- END

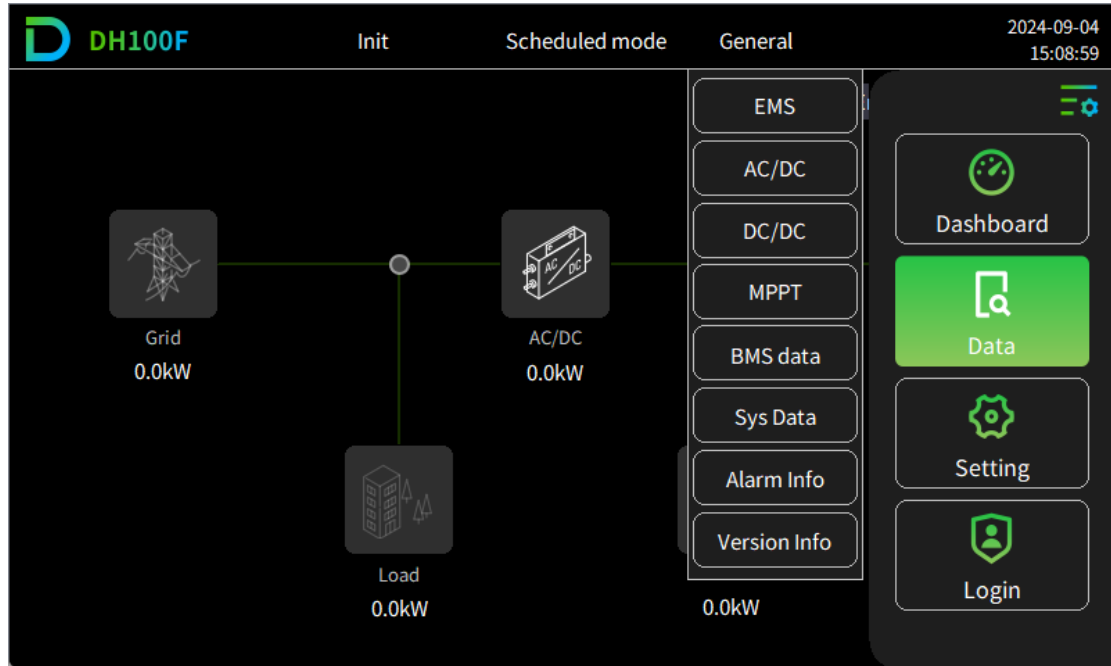



Figure 7-5 Query Data Diagram

7.6. EMS Setting

7.6.1. Run Setting

The operation setting interface is for setting the system setting and parameters.

- Step 1: Click [main menu icon](#)  on the upper right corner of the main interface;
- Step 2: Click ["Setting"](#) under main menu bar;
- Step 3: Click ["EMS"](#) under sub-menu bar;
- Step 4: Click ["RunSet"](#) at the upper left of navigation bar; Input related parameter value to complete setting.

--END

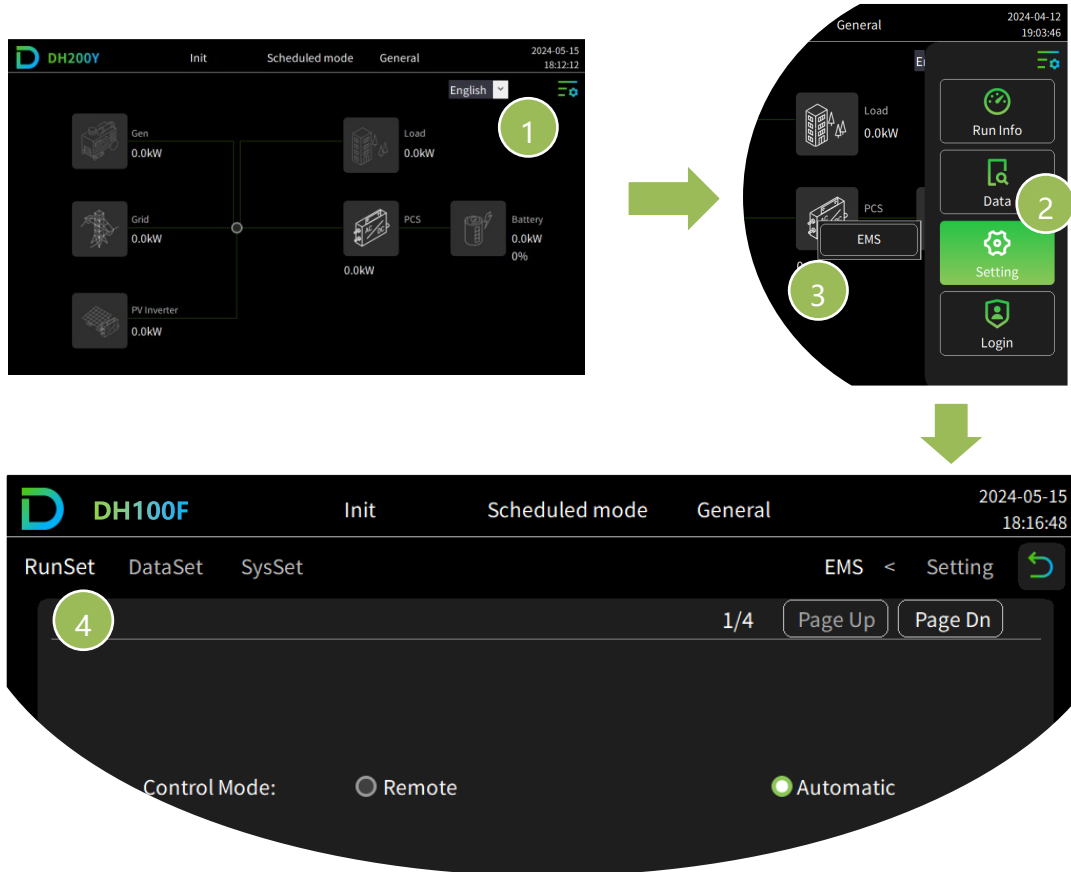

Figure 7-6 Running setting step

There are two control modes: remote and automatic

(1) Remote mode

System only accepts commands from external EMS which could control the system through the EMS of this product.

Set system parallel

When there are several products in parallel, need to set system parallel address and number of parallel.

Notice: 1 represents host, the other number represents slave.

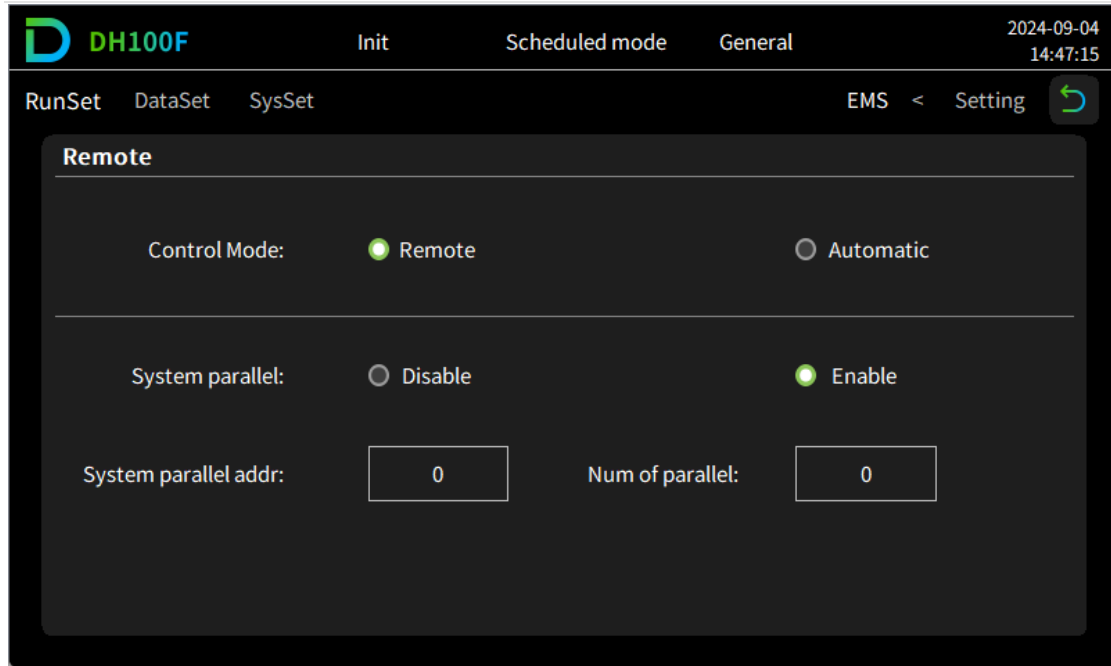

Figure 7-7 Remote Setting Step

(2) Automatic mode

Set system parallel

When there are several products in parallel, need to set system parallel address and number of parallel (1 represents host, the other number represents slave). The host machine need to be set in the next step while the slave are free from next operations.

Set mode:

- HMI / Web: The system can be set up through the local HMI and Dyness cloud platforms;
- HMI: the system can only be set up through local HMI;
- Web: The system can only be set up through the Dyness cloud platform.

DH100F Init Scheduled mode General 2024-09-04 14:52:11

RunSet DataSet SysSet EMS < Setting ↻

Auto 1/4 Page Up Page Dn

Control Mode: Remote Automatic

System parallel: Disable Enable

System parallel addr: Num of parallel:

Set Mode: HMI/Web HMI Web

DH100F Init Scheduled mode General 2024-09-04 14:53:51

RunSet DataSet SysSet EMS < Setting ↻

Auto 2/4 Page Up Page Dn

Anti-backflow consumption: Disable Enable

Grid-side Transf. protect: Disable Enable

Protect power limit(kW):

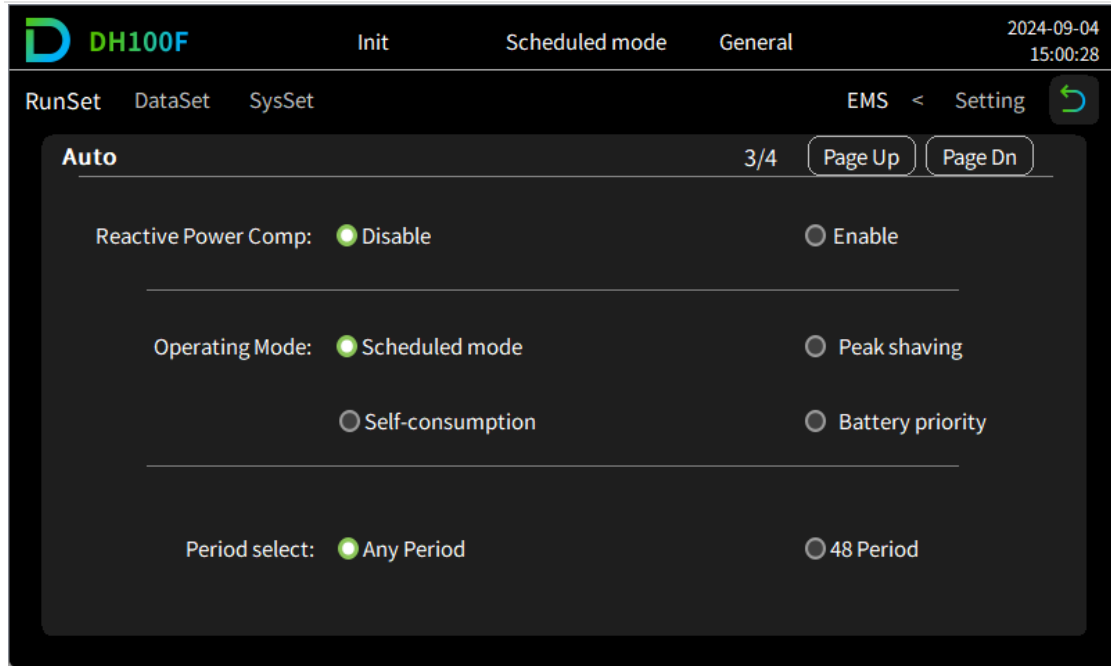

Figure 7-8 Automatic Setting Step(Total 3p)

Table 7-3 Automatic Mode Set

Item	Description
Anti-backflow	Disable: the system has no limitation over PV output; Enable: the system enables anti-backflow function to prevent PV output feed back to the grid.
Grid-side transformer powerprotect	If the load power exceeds the set demand power even with PV maximum output, the EMS will control the ESS system to discharge to reduce the excess power beyond the set demand power. Disable: the system has no transformer protection control; Enable: the system enables transformer protection function, and protect power limit value need to be set.
Reactive power compensation	Set system reactive compensation function. Disable: the system won't compensate reactive power; Enable: the system compensate reactive power. (Notice: automatic mode could be set)
Operating strategy	Scheduled mode: could set "any period" or "48 periods"; Peak-shaving: could set peak power value and valley power value under this mode; Self-consumption: could set priority mode and charging target power value under this mode.
Any period	Allows the system to select periods by month (1~4), with up to 4 sets of time periods possible (Period One, Period Two, Period Three, Period Four). The system operates for 7 days (Monday to Sunday), with each day having up to 10 periods. (Notice: settable under "Scheduled mode")
48 period	Allows the system to select periods by month (1~4), with up to 4 sets of time periods possible (Period One, Period Two, Period Three, Period Four). The system can divide each day into 48 time periods. (Notice: settable under "Scheduled mode")

Peak power (kW)	Set system peak power value, unit: kW (Notice: settable under "Peak shaving" mode)
Valley power (kW)	Set system valley power value, unit: kW (Notice: settable under "Peak shaving" mode)

7.6.2. Parameter Setting

Setting the relevant protection parameters of the ESS on parameter setting interface.

- Step 1: Click main menu icon  on the upper right corner of the main interface;
 - Step 2: Click "Setting" under main menu bar;
 - Step 3: Click "EMS" under sub-menu bar;
 - Step 4: Click "DataSet" at the upper left of navigation bar;
- END

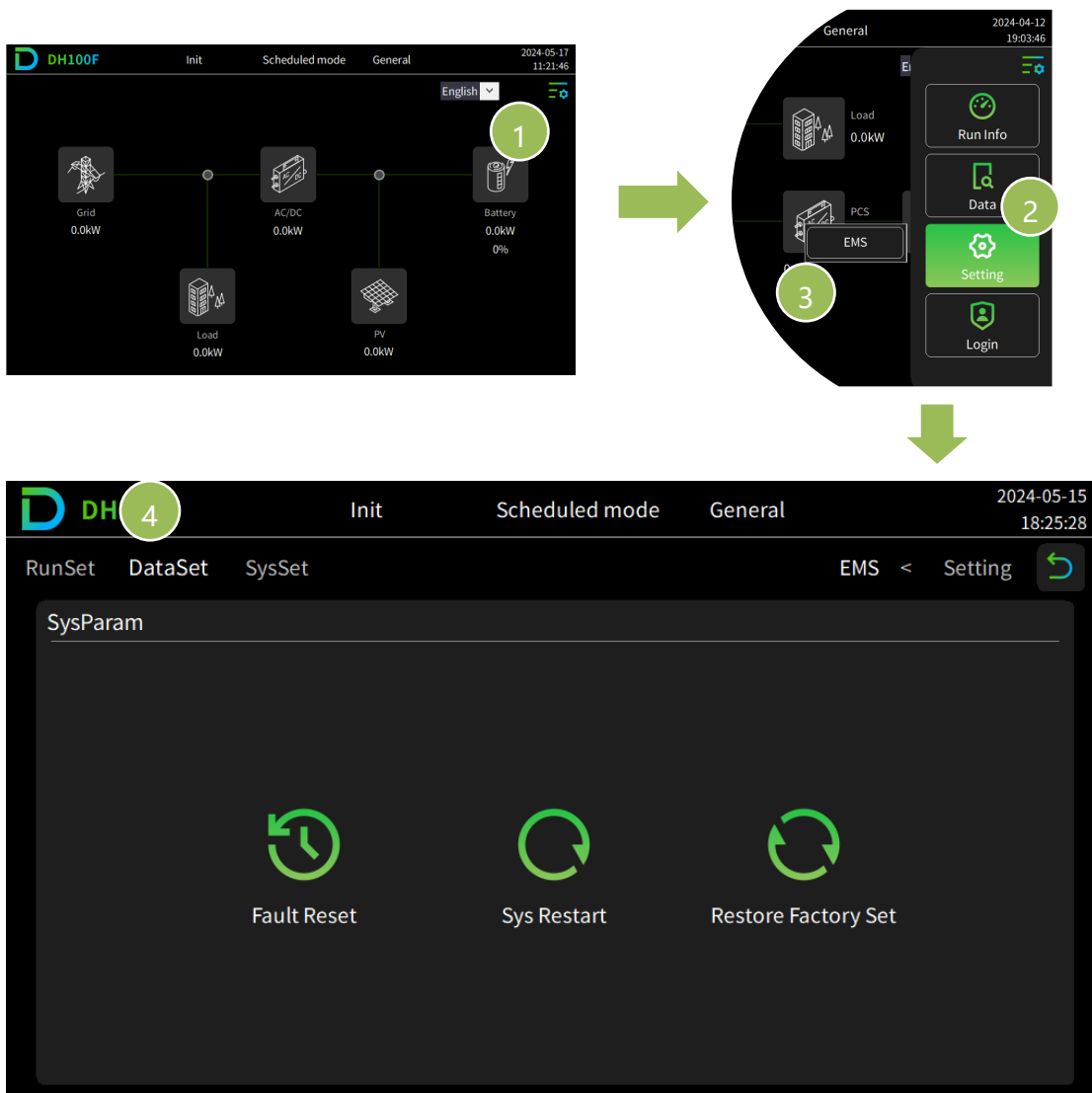



Figure 7-9 Parameter Setting Step
Table 7-4 System Control Description

Item	Description
Fault Reset	Reset for the system faults.
Sys Restart	Restart EMS (Notice: this operation is not possible when the system is running).
Restore factory Set	Safety regulation parameter, correction coefficient, power generation, no clear.

7.6.3. System Setting

Set HMI time/display format/language, EMS system time and etc.

- Step 1: Click [main menu icon](#)  on the upper right corner of the main interface;
- Step 2: Click "[Setting](#)" under main menu bar;
- Step 3: Click "[EMS](#)" under sub-menu bar;

Step 4: Click "[SysSet](#)" at the upper navigation bar and input relevant parameters.

--END

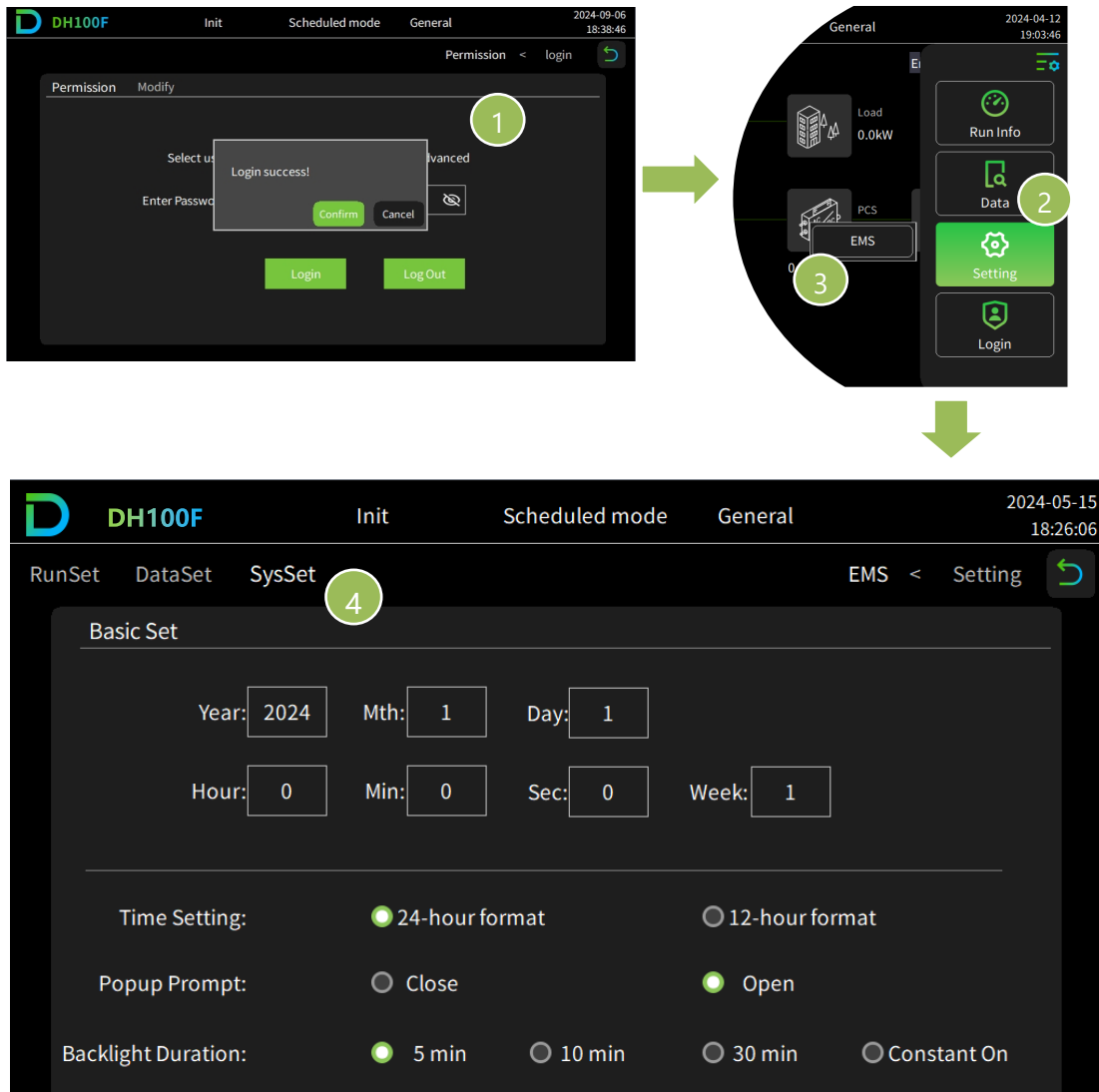

Figure 7-10 System Setting Step

Table 7-5 System Setting Description

Item	Description
HMI time	Set HMI display time
Time Setting	Set HMI display time system, 12-hour and 24-hour available
Popup prompt	Set HMI popup remind function, set to "open", reminder will popup when setting important parameters.
Backlight Duration	Set HMI backlight time.

7.7. Application Setting Step

7.7.1. Automatic Mode

1. Scheduled Mode

Step 1: Login (general user), password(1111).



- (1) Click **main menu icon**  on the upper right corner of the main interface;
- (2) Step 2: Click **"Login"** to enter the user interface under the main menu bar;
- (3) Step 3: Select **"General"**, input password(1111), click **"Login"**;
- (4) Step 4: Click **"Confirm"** in the prompt popup.



Figure 7-11 General User Login Step

Step 2: Enter "Setting" interface

- (1) Click **main menu icon**  on the upper right corner of the main interface;
- (2) Click **"Setting"** under main menu bar;
- (3) Click **"EMS"** under sub-menu bar;
- (4) Click **"RunSet"** at the upper left of navigation bar;
- (5) On **"1/4" page**, set **【Control mode】** to **"Automatic"**.

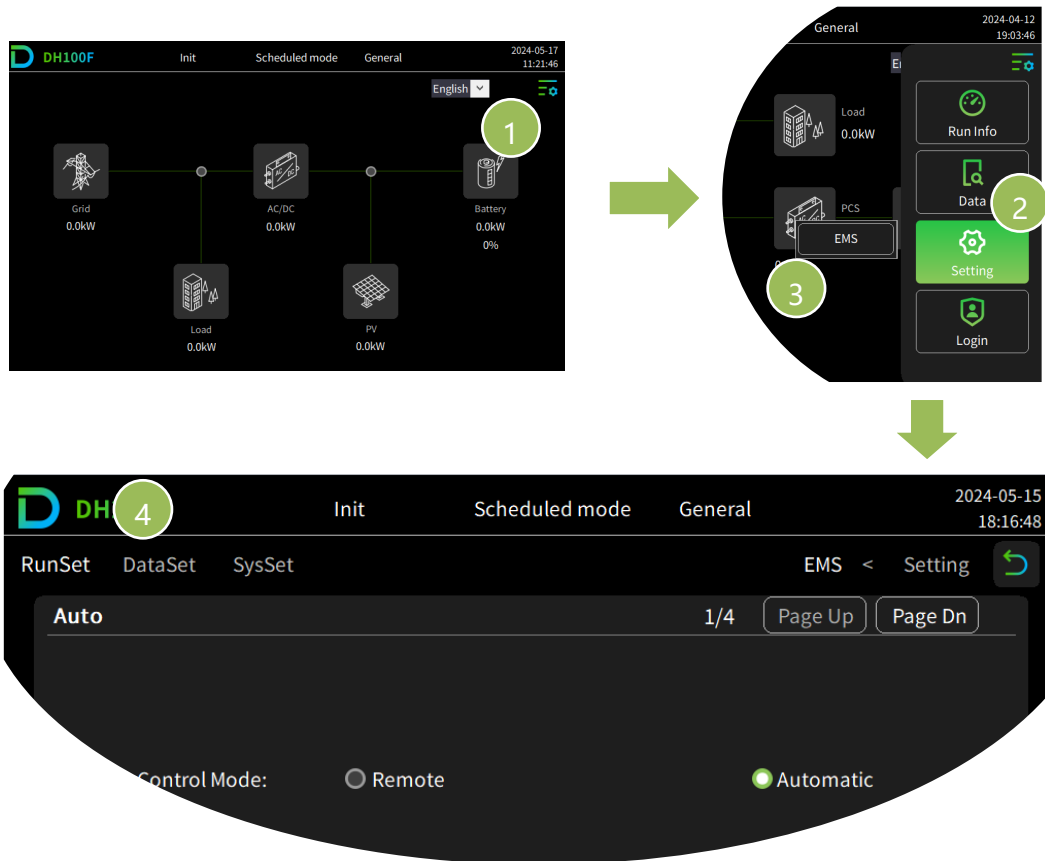

Figure 7-12 Run Setting Step

Step 3: Set Parallel and set method

- (1) Set **【System parallel】**: when there are multiple products in parallel, click "**enable**", and set the parallel address and the number of parallel (1 means the host, other means the slave). The host needs to do the next operation while the slave is free from next operation); otherwise click "**Disable**";
- (2) Set Mode: if select "**Web**", the rest of the operations are carried out on the Dyness cloud platform, if select "**HMI / Web**" or "**HMI**", click the next page.

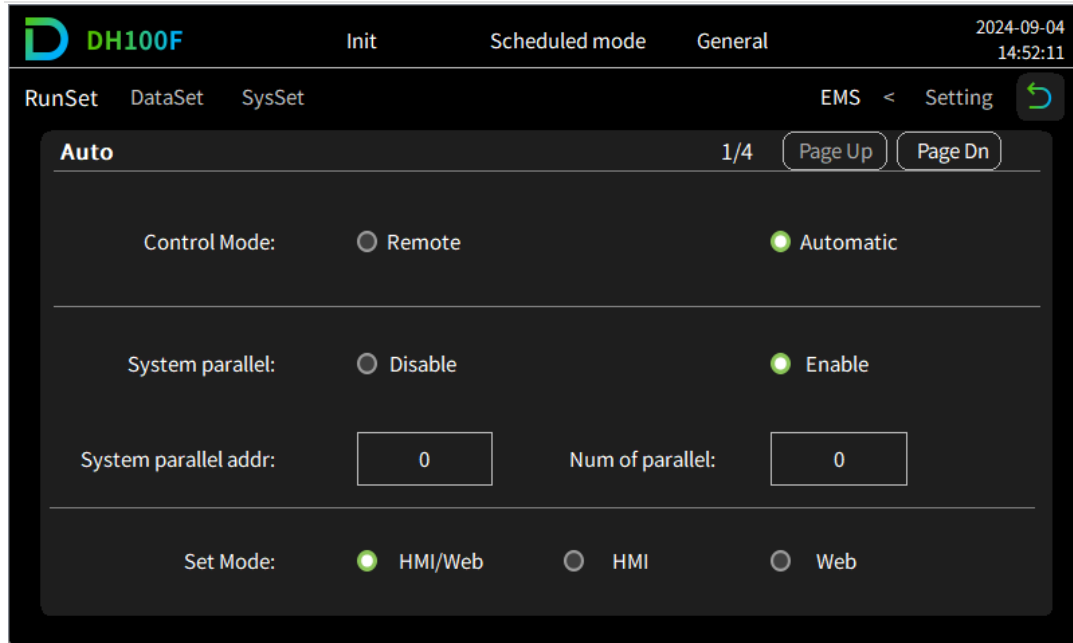
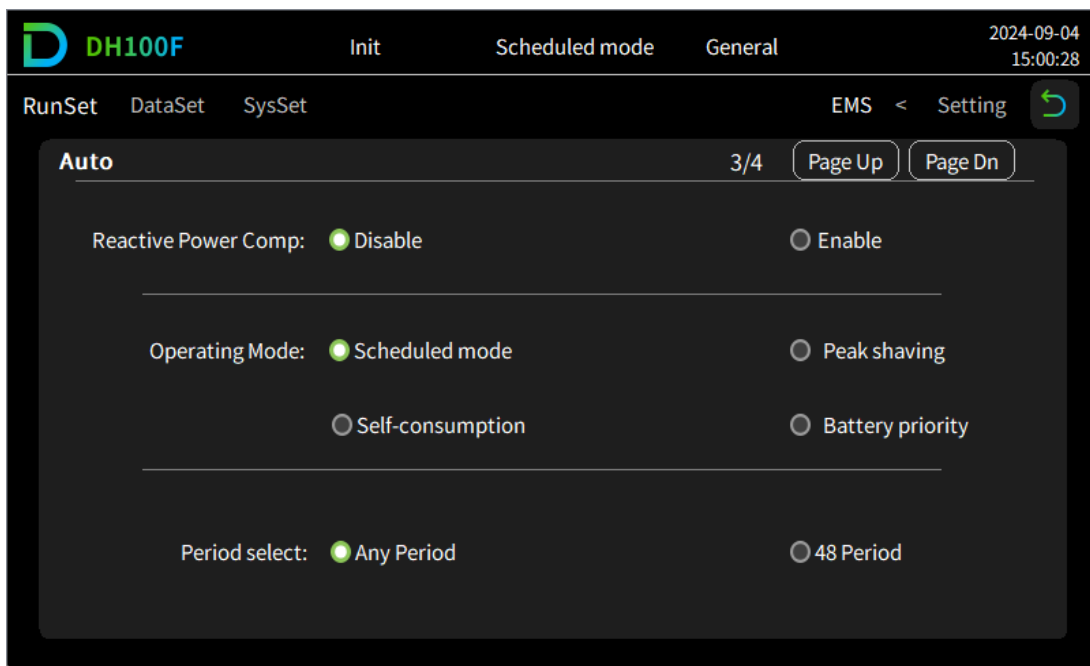
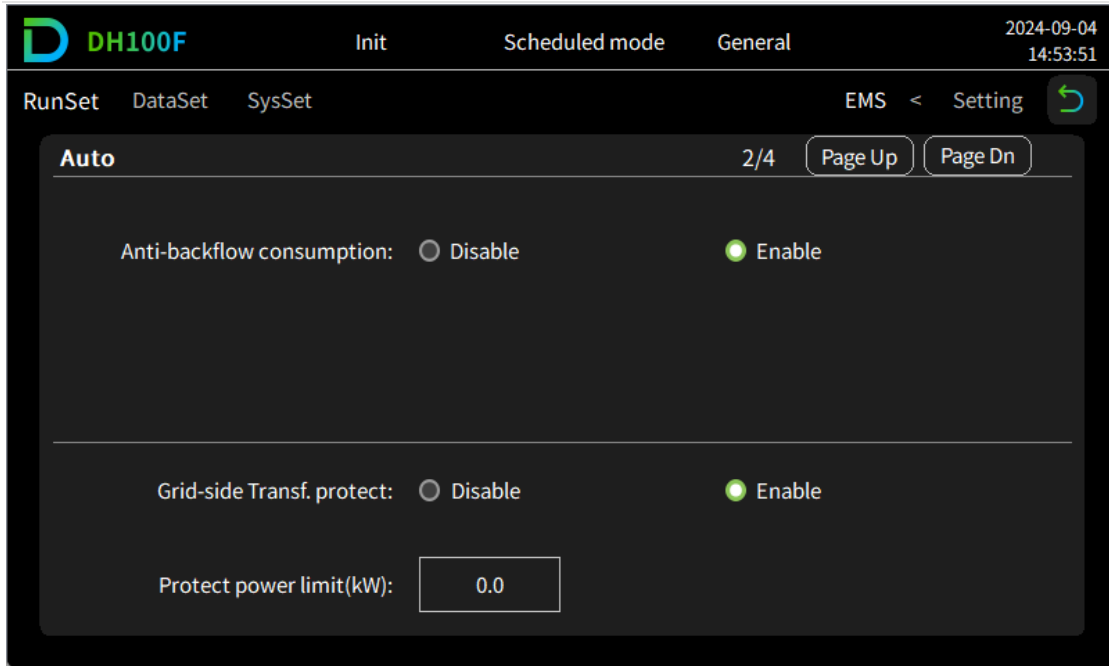

Figure 7-13 Parallel & Set Mode Step

Step 4: Set Scheduled mode

- (1) On "2/4" page, set **【Anti-backflow Compensation】**; Set **【Grid-side transf. Protect】**, set power value if click "enable";
 - (2) On "3/4" page, set **【Reactive Power Comp】**
 - (3) On "3/4" page, click "Scheduled mode"; and set to "48 periods"; or "Any period" based on projects requirements. then click "Page On" at the upper right corner;
 - (4) On "4/4" page, select the time period corresponding to each month (Period One/ Two/ Three/ Four) and S-P-F-V (Set 1/Set 2/Set 3/Set 4);
 - (5) Set start time and end time, corresponding power and SOC;
 - (6) Return to previous page, click "S-P-F-V", setting the time table.
- END



DH100F Init Scheduled mode General 2024-09-06 18:41:17

RunSet DataSet SysSet EMS < Setting

Auto 4/4 Page Up Page Dn

January:	<input type="text" value="0"/>	May:	<input type="text" value="0"/>	September:	<input type="text" value="0"/>
February:	<input type="text" value="0"/>	June:	<input type="text" value="0"/>	October:	<input type="text" value="0"/>
March:	<input type="text" value="0"/>	July:	<input type="text" value="0"/>	November:	<input type="text" value="0"/>
April:	<input type="text" value="0"/>	August:	<input type="text" value="0"/>	December:	<input type="text" value="0"/>

Period Select:

S-P-F-V:

DH100F Init Scheduled mode General 2024-09-04 15:03:06

RunSet DataSet SysSet EMS < Setting

Auto Any time period 1 Back Done

Num	Start Time	End Time	Power(kW)	SOC(%)
1	<input type="text" value="00"/> : <input type="text" value="00"/>	<input type="text" value="00"/> : <input type="text" value="00"/>	<input type="text" value="00"/>	<input type="text" value="0"/>
2	<input type="text" value="00"/> : <input type="text" value="00"/>	<input type="text" value="00"/> : <input type="text" value="00"/>	<input type="text" value="00"/>	<input type="text" value="0"/>
3	<input type="text" value="00"/> : <input type="text" value="00"/>	<input type="text" value="00"/> : <input type="text" value="00"/>	<input type="text" value="00"/>	<input type="text" value="0"/>
4	<input type="text" value="00"/> : <input type="text" value="00"/>	<input type="text" value="00"/> : <input type="text" value="00"/>	<input type="text" value="00"/>	<input type="text" value="0"/>
5	<input type="text" value="00"/> : <input type="text" value="00"/>	<input type="text" value="00"/> : <input type="text" value="00"/>	<input type="text" value="00"/>	<input type="text" value="0"/>
6	<input type="text" value="00"/> : <input type="text" value="00"/>	<input type="text" value="00"/> : <input type="text" value="00"/>	<input type="text" value="00"/>	<input type="text" value="0"/>
7	<input type="text" value="00"/> : <input type="text" value="00"/>	<input type="text" value="00"/> : <input type="text" value="00"/>	<input type="text" value="00"/>	<input type="text" value="0"/>
8	<input type="text" value="00"/> : <input type="text" value="00"/>	<input type="text" value="00"/> : <input type="text" value="00"/>	<input type="text" value="00"/>	<input type="text" value="0"/>
9	<input type="text" value="00"/> : <input type="text" value="00"/>	<input type="text" value="00"/> : <input type="text" value="00"/>	<input type="text" value="00"/>	<input type="text" value="0"/>
10	<input type="text" value="00"/> : <input type="text" value="00"/>	<input type="text" value="00"/> : <input type="text" value="00"/>	<input type="text" value="00"/>	<input type="text" value="0"/>

Mon	<input type="checkbox"/>
Tue	<input type="checkbox"/>
Wed	<input type="checkbox"/>
Thur	<input type="checkbox"/>
Fri	<input type="checkbox"/>
Sat	<input type="checkbox"/>
Sun	<input type="checkbox"/>
SOC limit	<input type="checkbox"/>

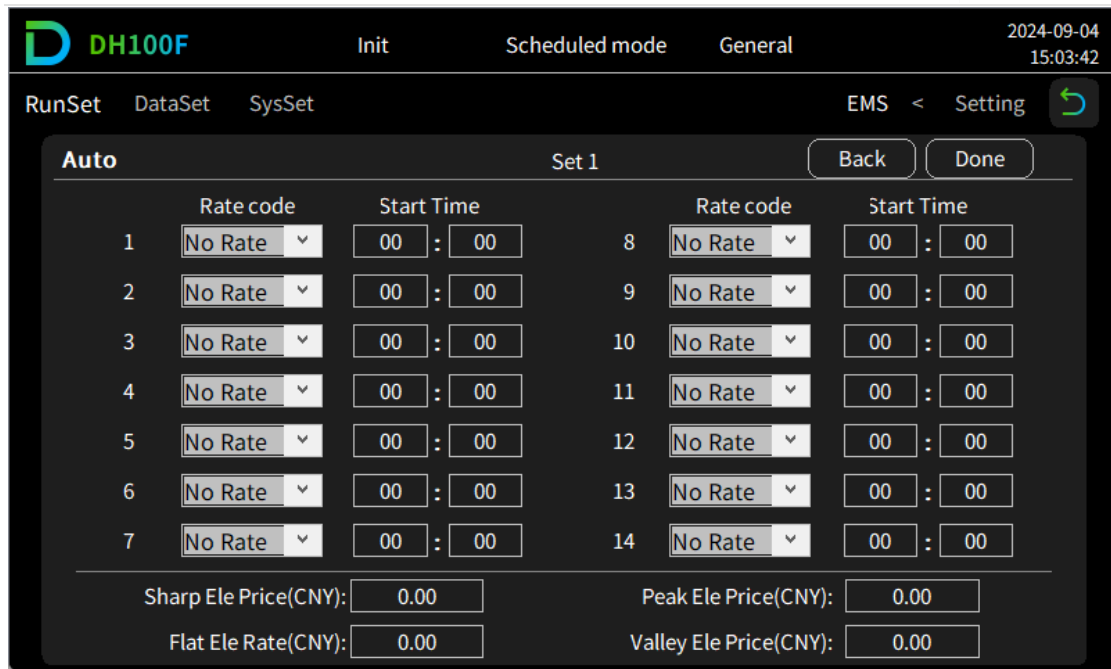



Figure 7-14 Scheduled Mode Setting Step(Total 5p)

2. Peak-shaving

Step 1: Login (general user), password(1111). (Refer to 7.7.1 "1.Scheduled Mode" Step 1)

- (1) Step 1: Click **main menu icon**  on the upper right corner of the main interface;
- (2) Step 2: Click "**Login**" to enter the user interface under the main menu bar;
- (3) Step 3: Select "**General**", input password(1111), click "**Login**";
- (4) Step 4: Click "**Confirm**" in the prompt popup.

Step 2: Enter "**setting**" interface. (Refer to 7.7.1 "1.Scheduled Mode" Step 2)

- (1) Step 1: Click **main menu icon**  on the upper right corner of the main interface;
- (2) Step 2: Click "**Setting**" under main menu bar;
- (3) Step 3: Click "**EMS**" under sub-menu bar;
- (4) Step 4: Click "**RunSet**" at the upper left of navigation bar;

Step 3: Set Parallel and set method. (Refer to 7.7.1 "1.Scheduled Mode" Step 3)

- (1) On "**1/4**" page, set **Control mode** to "**Automatic**";
- (2) Set **System parallel**: when there are multiple products in parallel, click "**enable**", and set the parallel address and the number of parallel (1 means the host, other means the slave). The host needs to do the next operation while the slave is free from next operation); otherwise click "**Disable**";
- (3) Set Mode: if select "**Web**", the rest of the operations are carried out on the Dyness cloud platform, if select "**HMI / Web**" or "**HMI**", click the next page;

Step 4: Set to "Peak shaving mode".

- (1) On "2/4" page, set **【Anti-backflow】**; Set **【Grid-side transf. Protect】**, set power value if click "enable";
- (2) On "3/4" page, set **【Reactive Power Compensation】**;
- (3) On "3/4" page, set **【Operating mode】** to "Peak-shaving";
- (4) Set **【Peak power (kW)】** and **【Valley power (kW)】**.

-- END

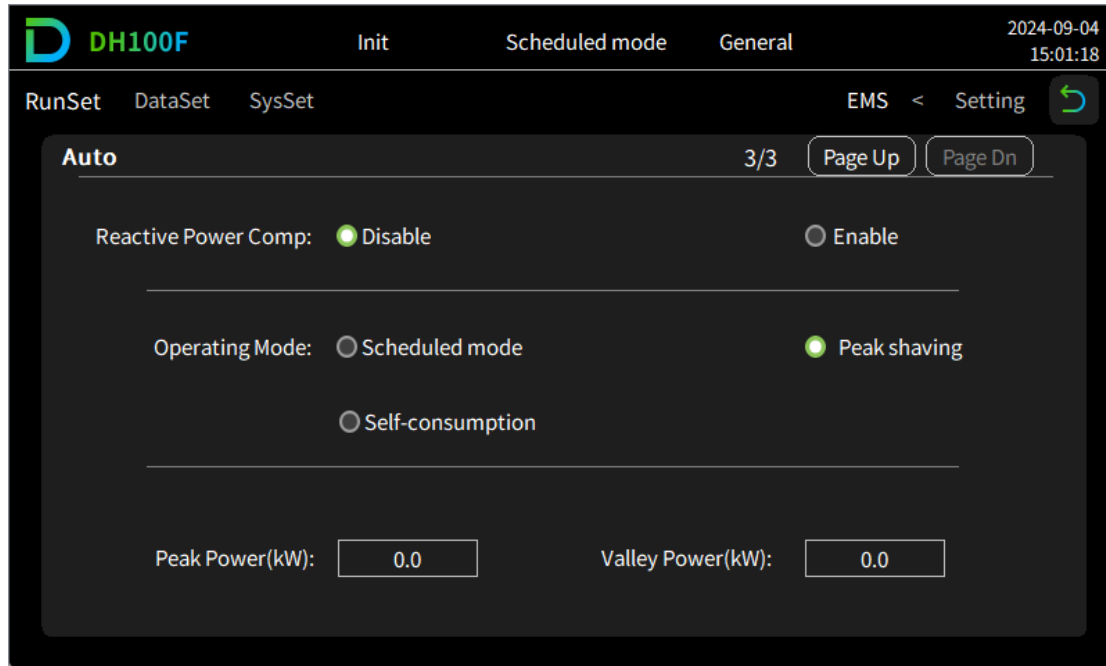



Figure 7-15 Peak-shaving Setting Step

3. Self-consumption

Step 1: Login (general user), password(1111). (Refer to 7.7.1 "1.Scheduled Mode" Step 1)

- (1) Click **main menu icon**  on the upper right corner of the main interface;
- (2) Click **“Login”** to enter the user interface under the main menu bar;
- (3) Select **“General”**, input password(1111), click **“Login”**;
- (4) Click **“Confirm”** in the prompt popup.

Step 2: Enter "setting" interface. (Refer to 7.7.1 "1.Scheduled Mode" Step 2)

- (1) Click **main menu icon**  on the upper right corner of the main interface;
- (2) Click **“Setting”** under main menu bar;
- (3) Click **“EMS”** under sub-menu bar;
- (4) Click **“RunSet”** at the upper left of navigation bar;

Step 3: Set Parallel and set method. (Refer to 7.7.1 "1.Scheduled Mode" Step 3)

- (1) On "1/4" page, set **【Control mode】** to "Automatic";
- (2) Set **【System parallel】**: when there are multiple products in parallel, click "enable", and set the parallel address and the number of parallel (1 means the host, other means the slave). The host needs to do the next operation while the slave is free from next operation); otherwise click "Disable";
- (3) Set Mode: if select "Web", the rest of the operations are carried out on the Dyness cloud platform, if select "HMI / Web" or "HMI", click the next page.

Step 4: Set to " Self-consumption mode".

- (1) On "2/4" page, set **【Anti-backflow】**; Set **【Grid-side transf. Protect】**, set power value if click "enable";
- (2) On "3/4" page, set **【Reactive Power Compensation】**;
- (3) On "3/4" page, set **【Operating mode】** to "Peak-shaving";
- (4) Select **【Grid Charging】**, set "Grid start/stop charging".

-- END

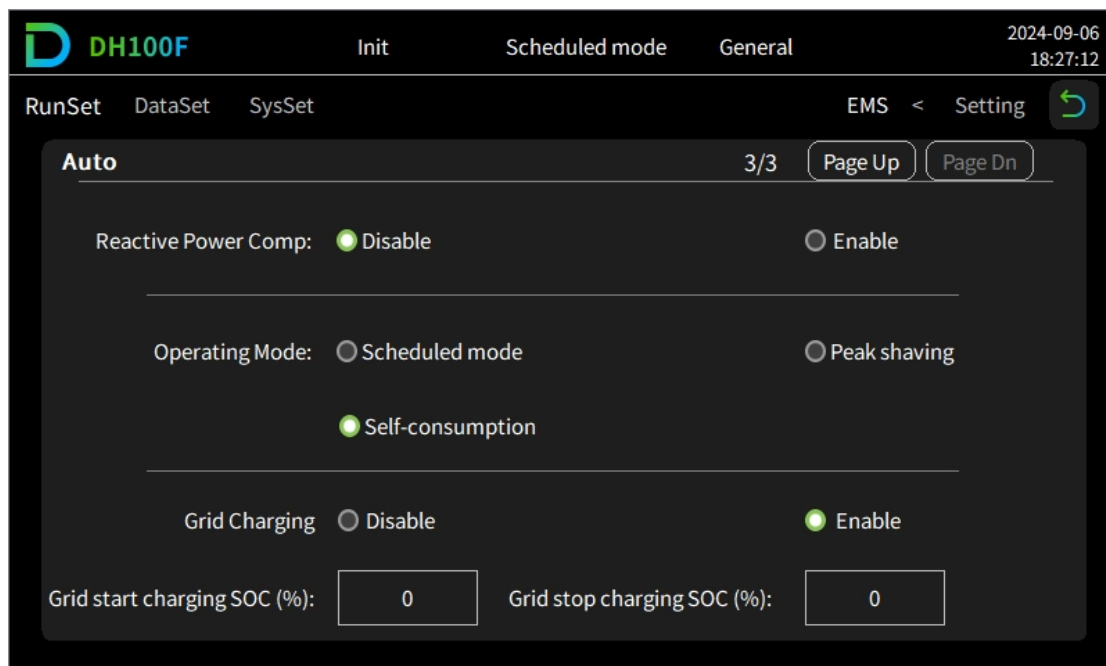



Figure 7-16 Self-consumption Setting Step

7.7.2. Remote Mode

Step 1: Login (general user), password(1111). (Refer to 7.3 "User Login")

- (1) Click **main menu icon**  on the upper right corner of the main interface;
- (2) Click "Login" to enter the user interface under the main menu bar;
- (3) Select "General", input password(1111), click "Login";
- (4) Click "Confirm" in the prompt popup.

Step 2: Enter "setting" interface (Refer to 7.6 "EMS Setting")

- (1) Click **main menu icon**  on the upper right corner of the main interface;
- (2) Click "Setting" under main menu bar;
- (3) Click "EMS" under sub-menu bar;
- (4) Click "RunSet" at the upper left of navigation bar.

Step 3: Set Remote mode

- (1) Set **Control mode** to "Remote";
- (2) Set **System parallel**: when there are multiple products in parallel, click "enable", and set the parallel address and the number of parallel (1 means the host, other means the slave). The host needs to do the next operation while the slave is free from next operation); otherwise click "Disable".

-- END

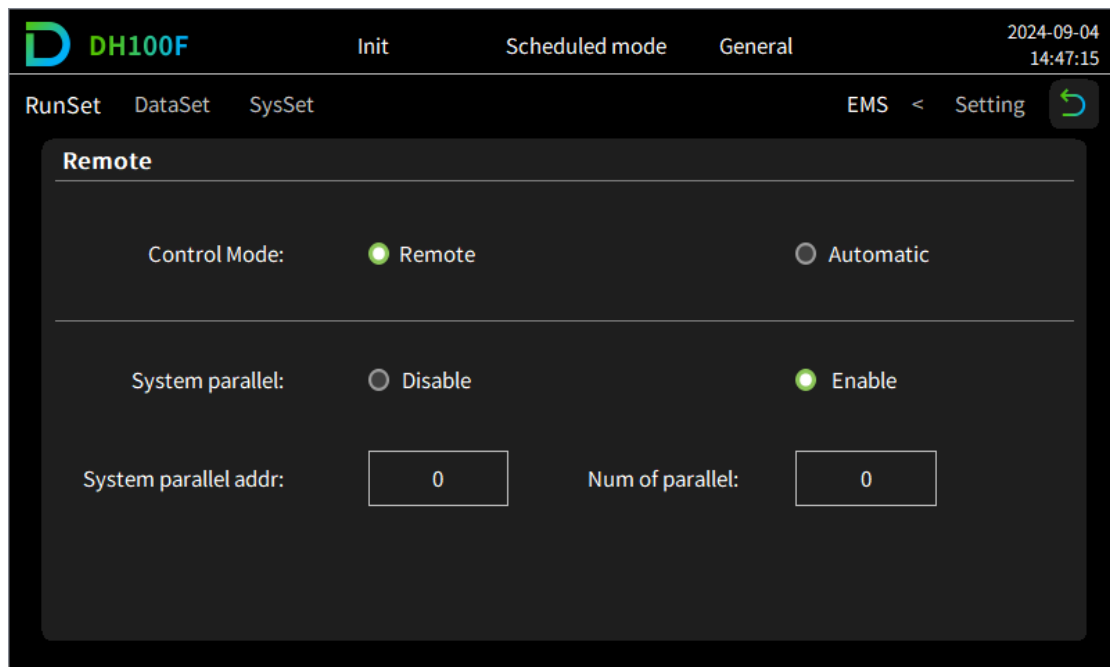

Figure 7-17 Remote Mode Setting Step

8. Fault Description

If the solution provided below still does not solve the problem, please contact Dyness.

Table 8-1 Fault description and solution

Fault phenomenon	Solution
Power light off	<ul style="list-style-type: none"> • Check that each circuit breaker is closed
Running light off	<ul style="list-style-type: none"> • Check if EMS is in running state
Alarm light on	<ul style="list-style-type: none"> • Check whether there is any alarm through the screen or the web, whether it is caused by improper operation, if not, please contact Dyness after-sales service
Show access alarm	<ul style="list-style-type: none"> • check if the door is closed
Show flood alarm	<ul style="list-style-type: none"> • Check whether the system is flooded, or whether the water sensor line is disconnected or damaged
Show emergency stop Alarm	<ul style="list-style-type: none"> • Check if the EPO button is normal
Show SPD alarm	<ul style="list-style-type: none"> • Check whether the lightning protector is damaged and whether the fault light is on. If it is damaged, please contact the after-sales service for replacement
Show gas detector alarm	<ul style="list-style-type: none"> • Stop using it immediately and contact the manufacturer for after-sales service
Show temperature detector alarm	<ul style="list-style-type: none"> • Stop using it immediately and contact the manufacturer for after-sales service
Show smoke detector alarm	<ul style="list-style-type: none"> • Stop using it immediately and contact the manufacturer for after-sales service
Show other alarm	<ul style="list-style-type: none"> • Need to contact the manufacturer for after-sales
Abnormal anti-backflow	<ul style="list-style-type: none"> • Check whether the anti-backflow meter is set correctly and whether the meter is correctly installed; • Check whether the PE cable of the EMS is grounded; • If the fault information still exists, please contact the manufacturer.
Abnormal communication between EMS and BMS	<ul style="list-style-type: none"> • Shutdown to check if the communication cable is firmly connected and correct; • Restart the EMS and check if it functions normally; • If the error message still exists, please contact the manufacturer.
Abnormal communication between EMS and fire protection module	<ul style="list-style-type: none"> • Shutdown to check if the communication cable is firmly connected and correct; • Restart the EMS and check if it functions normally; • If the error message still exists, please contact the manufacturer.

Abnormal communication between EMS and PCS	<ul style="list-style-type: none"> • Shutdown to check if the communication cable is firmly connected and correct; • Restart the EMS and check if it functions normally; • If the error message still exists, please contact the manufacturer.
Abnormal communication between EMS and DCDC	<ul style="list-style-type: none"> • Shutdown to check if the communication cable is firmly connected and correct; • Restart the EMS and check if it functions normally; • If the error message still exists, please contact the manufacturer.
Abnormal communication between EMS and meter	<ul style="list-style-type: none"> • Shutdown to check if the communication cable is firmly connected and correct; • Restart the EMS and check if it functions normally; • If the error message still exists, please contact the manufacturer.
Abnormal communication between EMS and air conditioner	<ul style="list-style-type: none"> • Shutdown to check if the communication cable is firmly connected and correct; • Restart the EMS and check if it functions normally; • If the error message still exists, please contact the manufacturer.
Abnormal communication between EMS and HMI	<ul style="list-style-type: none"> • Check the meter cables after shutdown; • If the error message still exists, please contact the manufacturer.
SD card detect abnormality	<ul style="list-style-type: none"> • Check if the SD card is normal, if not please replace the SD card; • If the error message still exists, please contact the manufacturer.
Network abnormality - (default blocked)	<ul style="list-style-type: none"> • check the 4G/WIFI/LAN antenna • If the error message still exists, please contact the manufacturer.
EMS power loss saving abnormality	<ul style="list-style-type: none"> • If the error message still exists, please contact the manufacturer.
EMS external Flash abnormality	<ul style="list-style-type: none"> • If the error message still exists, please contact the manufacturer.
System version inconsistency abnormality	<ul style="list-style-type: none"> • Restart PCS and check if it is normal; • If the error message still exists, please contact the manufacturer.
Parallel communication loss	<ul style="list-style-type: none"> • Restart PCS and check if it is normal;

	<ul style="list-style-type: none">• If the error message still exists, please contact the manufacturer.
Parallel host loss	<ul style="list-style-type: none">• Restart PCS and check if it is normal;• If the error message still exists, please contact the manufacturer.
Parallel gird input inconsistency	<ul style="list-style-type: none">• If the error message still exists, please contact the manufacturer.
Parallel input phase sequence error	<ul style="list-style-type: none">• If the error message still exists, please contact the manufacturer.
Parallel output phase deficiency	<ul style="list-style-type: none">• If the error message still exists, please contact the manufacturer.
Incompatible software versions prevent parallel operation	<ul style="list-style-type: none">• If the error message still exists, please contact the manufacturer.
Inconsistent capacities prevent parallel operation	<ul style="list-style-type: none">• If the error message still exists, please contact the manufacturer.

9. System Maintenance

Start inspecting only after the internal equipment of the ESS cabinet is completely powered off during system maintenance! During the inspection, if non-conformance are found, please correct them immediately.

The system need to be maintained in regular. The maintenance checklist and frequency are listed in the following table.

Table 9-1 System maintenance checklist

Items	Checklist	Frequency
Cabinet exterior	• Check if there are any flammable materials on the ESS cabinet	once/year
	• Check if the ESS cabinet and expansion bolts are secure and free from rust	
	• Check if there are any damage, peeling paint, and oxidation on the ESS cabinet casing	
	• Check if the cabinet door locks can open smoothly.	
System status	• Check if the sealing strips are securely fixed	once/year
	• Check if the ESS cabinet and internal equipment are damaged or deformed	
	• Check if the warning signs and labels are clear and visible. Replace them if necessary.	
	• Check if there are any loose or missing screws inside the ESS cabinet	
	• Check if the cable shielding layer is in good contact with the insulation sleeve;	
	• Check if the grounding copper bar is securely fixed in place.	
Wiring and cable arrangement	• Check if there are any oxidation or rust inside the ESS cabinet.	once/year
	• Check if all the inlet/outlet of the ESS cabinet are sealed properly.	
	• Check if there are any water leakage inside the ESS cabinet;	
	• Check if the power cables are loose, tighten them according to previously specified torque.	
	• Check if there are any damage for power cables and control cables, especially check for cuts on the insulation where they contact metal surfaces.	
	• Check if the insulation wrapping of cable terminals are falling off	
	• Check if the PE cable connection is correct, the grounding resistance value should not exceed 1Ω	
• Check if the equipotential connections inside the ESS cabinet are correct.		
System cleanliness	• Check if the inlet/outlet of ESS cabinet are blocked. Please clean them if needed.	once/ half year
	• Check if the humidity inside is ESS cabinet is within the normal range, Please clean them if needed.	
	• check if there are foreign objects, dust, dirt and condensation inside the ESS cabinet.	

	<ul style="list-style-type: none"> • Check if there are condensation inside the ESS cabinet regularly; • Once a year for areas with low relative humidity; • One half year for areas with medium relative humidity; • Once every one to three months for areas with high relative humidity; 	
System function	<ul style="list-style-type: none"> • Check if there are abnormal noise inside the ESS cabinet during operation • Check if the temperature is too high inside the ESS cabinet. • Check if the system operates normal for startup and shutdown. 	once/ two years
Fan	<ul style="list-style-type: none"> • Check the operation status of fan. • Check if the fan is blocked. 	once/year
Air conditioner	<ul style="list-style-type: none"> • Check if there are abnormal noise during fan operation. • Check the operation status of air conditioner. • Check if the air conditioner is blocked. • Check if there are abnormal noise during air conditioner operation. 	once/year
Safety function	<ul style="list-style-type: none"> • Check the stop function of EPO and screen, and simulate shutdown for test. • Check the warning signs and other labels, please replace them if there are any damage or blur. 	once/half year ~ year
Device maintenance	<ul style="list-style-type: none"> • Perform a regular inspection for rust condition of all metal components (once every half year) • Annual inspection of the contactor (auxiliary switch and micro-switch) to ensure that the product runs well. • Check the operating parameters (especially voltage and insulation parameter) 	once/half year ~ year

10. Quality Assurance

Warranty period please refer to "Technical Agreement" and "Warranty Agreement"

Service within warranty period: for Dyness ESS products that fail within warranty period, we will be responsible for handling and providing proper replacement or repair solution, offering free services or replacement of failure products. We will require valid invoices and receipts of purchase for warranty. Meanwhile, the Dyness trademark should be visible to ensure the validity of assurance.

We reserve the right not to provide warranty in the following situations:

- The ESS products exceed the free warranty period;
- Improper installation, modification or usage;
- Operation under harsh environments beyond those specified in this document or "Warranty Agreement" or "Technical Agreement", or damage caused by abnormal natural environmental factors;
- Damage or failure caused by installation, modification and disassembly from unauthorized agencies or individuals;
- Damage or failure caused by the use of non-standard products or unauthorized components and software.

For failures caused by the above situations, Dyness could provide paid maintenance services if customer require.

If you have any problems about this product, please contact us. In order to solve your problem more quickly, please provide the following information:

- Original purchase receipt or invoice;
- Contact information, including name, phone number, email address and shipping address;

Product information, including product model, product serial number, installation date and location, fault date and fault description, etc.

11. Appendix

Please check if the following checklist have been completed before product runs.

Table 11-1 Checklist before operation

Items	Checklist	Confirm
1	• Check if the appearance is damaged and if the internal equipment is intact;	<input type="checkbox"/>
2	• Check if the assembly is firm;	<input type="checkbox"/>
3	• Check if the logo and labels of ESS cabinet and components are clear or damaged;	<input type="checkbox"/>
4	• Check if the grid AC cables are connected in correct phase sequence;	<input type="checkbox"/>
5	• Check if the PV cables are connected in correct phase sequence;	<input type="checkbox"/>
6	• Check if the communication cable connection is completed;	<input type="checkbox"/>
7	• Check if there are any faults of PE cable;	<input type="checkbox"/>
8	• Check if the liquid cooling pipes are well connected and check if there are any leakage.	<input type="checkbox"/>
9	• Check if the meter reads correctly;	<input type="checkbox"/>
10	• Check if all the connection points are correct and have good contact.	<input type="checkbox"/>
11	• Check if there are no abnormal situation of manual components.	<input type="checkbox"/>
12	• Check if the circuit breakers functioning normally;	<input type="checkbox"/>
13	• Check if all the buttons and related indicators are functioning normally;	<input type="checkbox"/>
14	• Check if the power indicator is normal;	<input type="checkbox"/>
15	• Check if the running indicator is normal;	<input type="checkbox"/>
16	• Check if fan and air conditioner is running well and no abnormal sound.	<input type="checkbox"/>
17	• Check if the HMI screen is normal and there are no error messages;	<input type="checkbox"/>
18	• Check if there are any tools or components left inside the ESS cabinet;	<input type="checkbox"/>
19	• Check if the door of SEE cabinet could open and close smoothly.	<input type="checkbox"/>

DYNNESS

DISCOVER YOUR NATURE

Address: No. 511 Chenzhuang West Road, Sanshui Street,
Jiangyan District, Taizhou City

Email: service@dyness-tech.com

Tel: +86 400 666 0655

Web: www.dyness.com



Official Website



Digital version access